

POWERLine

2521 PREMIUM

INSTRUCTION MANUAL

This instruction manual applies to machines from software version 0389/002 and serial number 2 788 828 onwards. →



This Instruction Manual is valid for all models and subclasses listed in the chapter "Specifications".



The adjustment manual for the machines can be downloaded free of charge from the internet address

www.pfaff-industrial.com/pfaff/de/service/downloads

As an alternative to the internet download the adjustment manual can also be ordered in book form under part no. **2296-12-19 156/002**.

The reprinting, copying or translation of PFAFF Instruction Manuals, whether in whole or in part, is only permitted with our previous authorization and with written reference to the source.

**PFAFF Industriesysteme
und Maschinen AG**

Hans-Geiger-Str. 12 - IG Nord

D-67661 Kaiserslautern

	Page
Contents	Page
1 Safety	5
1.01 Directives	5
1.02 General notes on safety	5
1.03 Safety symbols	6
1.04 Important points for the user	6
1.05 Operating and specialist personnel	7
1.05.01 Operating personnel	7
1.05.02 Specialist personnel	7
1.06 Danger warnings	8
2 Proper use.....	9
3 Specifications	10
3.01 PFAFF 2521	10
3.02 Machine equipment and options	11
4 Disposal of Machine	12
5 Transportation, packing and storage	13
5.01 Transportation to customer's premises	13
5.02 Transportation inside the customer's premises	13
5.03 Disposal of packing materials	13
5.04 Storage	13
6 Explanation of symbols.....	14
7 Controls	15
7.01 On/off switch / Sewing lamp switch (option)	15
7.02 Pedal	15
7.03 Keyboard on machine head.....	16
7.04 Lever for raising the roller presser	18
7.05 Swivel out the roller-presser	18
7.06 Knee lever	19
7.07 Knee switch	19
7.08 Bobbin thread monitoring with stitch counting	20
7.09 Bobbin thread supply monitor (option -926/06).....	20
7.10 Control panel.....	21
7.10.01 Symbols on the display	21
7.10.02 +/- keys	22
7.10.03 Function keys	22
8 Preparation	24
8.01 Inserting the needle	24
8.02 Winding the bobbin thread, regulating the winder tension.....	25
8.03 Bobbin-changing/threading, and regulating the bobbin thread tension.....	26

	Contents	Page
8.04	Threading needle thread and regulating its tension	27
8.05	Setting the stitch length	28
8.05.01	Entering the standard stitch length	28
8.05.02	Entering a second stitch length or fullness	28
8.06	Entering the start and end backtacks	29
8.07	Entering/changing the template code	30
8.07.01	Entering the template code	30
8.07.02	Changing the template code	31
8.08	Setting the stitch counting function for the bobbin thread control	32
8.09	Setting the stitch counting function for the bobbin thread supply monitor (on machines with sub-class -926/06)	33
8.10	Inserting and removing the SD-memory card	34
9	Sewing	35
9.01	Manual sewing	35
9.02	Programmed sewing	36
9.03	Program interrupt	37
9.04	Error messages	38
10	Input	39
10.01	Overview of functions in input mode	39
10.01.01	Overview of parameter functions	39
10.01.02	Overview of seam program input	40
10.02	Seam program input variants	42
10.03	Changing available seam programs	43
10.04	Delete seam programs	46
10.05	Examples for seam programming	47
10.05.01	Example for seam program input	47
10.05.02	Example for seam input via teach-in	54
10.06	Program management	58
10.06.01	Calling up program management	58
10.06.02	Displaying programs in the machine memory	59
10.06.03	Displaying programs and machine data on the SD memory card	60
10.06.04	Copying programs and machine data onto the SD memory card	61
10.06.05	Copying programs and machine data in the machine memory	62
10.06.06	Deleting programs in the machine memory	63
10.06.07	Deleting programs and machine data on the SD memory card	64
10.06.08	Formatting the SD memory card	65
10.07	List of parameters for control P320 / P321	66
10.08	Error Messages and Description	70
10.09	Motor Errors	71
11	Care and maintenance	72
12	Wearing parts	76

1 Safety

1.01 Directives

The machine has been constructed in accordance with the requirements listed in the EC Declaration of Conformity and the Declaration of Incorporation.

In addition to this Instruction Manual, also observe all generally accepted, statutory and other regulations and legal requirements and all valid environmental protection regulations! The regionally valid regulations of the social insurance society for occupational accidents or other supervisory organizations are to be strictly adhered to!

1.02 General notes on safety

- This machine may only be operated by adequately trained operators and only after having completely read and understood the Instruction Manual!
- All Notes on Safety and Instruction Manuals of the motor manufacturer are to be read before operating the machine!
- The danger and safety instructions on the machine itself are to be followed!
- This machine may only be used for the purpose for which it is intended and may not be operated without its safety devices. All safety regulations relevant to its operation are to be adhered to.
- When exchanging sewing tools (e.g. needle, roller presser, needle plate and bobbin), when threading the machine, when leaving the machine unattended and during maintenance work, the machine is to be separated from the power supply by switching off the On/Off switch or by removing the plug from the mains!
- Everyday maintenance work is only to be carried out by appropriately trained personnel!
- Repairs and special maintenance work may only be carried out by qualified service staff or appropriately trained personnel!
- Work on electrical equipment may only be carried out by appropriately trained personnel!
- Work is not permitted on parts and equipment which are connected to the power supply! The only exceptions to this rule are found in the regulations EN 50110.
- Modifications and alterations to the machine may only be carried out under observance of all the relevant safety regulations!
- Only spare parts which have been approved by us are to be used for repairs! We expressly point out that any replacement parts or accessories which are not supplied by us have not been tested and approved by us. The installation and/or use of any such products can lead to negative changes in the structural characteristics of the machine. We are not liable for any damage which may be caused by non-original parts.

1.03 Safety symbols



Danger!
Points to be observed.



Danger of injury for operating and specialist personnel!



Caution

Do not operate without finger guard and safety devices.
Before threading, changing bobbin and needle, cleaning etc. **switch off main switch.**

1.04 Important points for the user

- This Instruction Manual is an integral part of the machine and must be available to the operating personnel at all times.
- The Instruction Manual must be read before operating the machine for the first time.
- The operating and specialist personnel is to be instructed as to the safety equipment of the machine and regarding safe work methods.
- It is the duty of the user to only operate the machine in perfect running order.
- It is the obligation of the user to ensure that none of the safety mechanisms are removed or deactivated.
- It is the obligation of the user to ensure that only authorized persons operate and work on the machine.

Further information can be obtained from your PFAFF agent.

1.05 Operating and specialist personnel

1.05.01 Operating personnel

Operating personnel are persons responsible for the equipping, operating and cleaning of the machine as well as for taking care of problems arising in the sewing area.

The operating personnel is required to observe the following points and must:

- always observe the Notes on Safety in the Instruction Manual!
- never use any working methods which could adversely affect the safety of the machine!
- not wear loose-fitting clothing or jewelery such as chains or rings!
- also ensure that only authorized persons have access to the potentially dangerous area around the machine!
- always immediately report to the person responsible any changes in the machine which may limit its safety!

1.05.02 Specialist personnel

Specialist personnel are persons with a specialist education in the fields of electrics, electronics and mechanics. They are responsible for the lubrication, maintenance, repair and adjustment of the machine.

The specialist personnel is obliged to observe the following points and must:

- always observe the Notes on Safety in the Instruction Manual!
- switch off the On/Off switch before carrying out adjustments or repairs, and ensure that it cannot be switched on again unintentionally!
- wait until the luminous diode on the control box is no longer blinking or on before beginning adjustment or repair work.
- never work on parts which are still connected to the power supply! Exceptions are explained in the regulations EN 50110.
- replace the protective coverings and close the electrical control box after all repairs or maintenance work!

1.06

Danger warnings



A working area of 1 m must be kept free both in front of and behind the machine, so that easy access is possible at all times.



Never put your hands or fingers in the sewing area during sewing!
Danger of injury by the needle!



While setting or adjusting the machine do not leave any objects on the table nor in the needle plate area! Objects may be trapped or flung out of the machine!

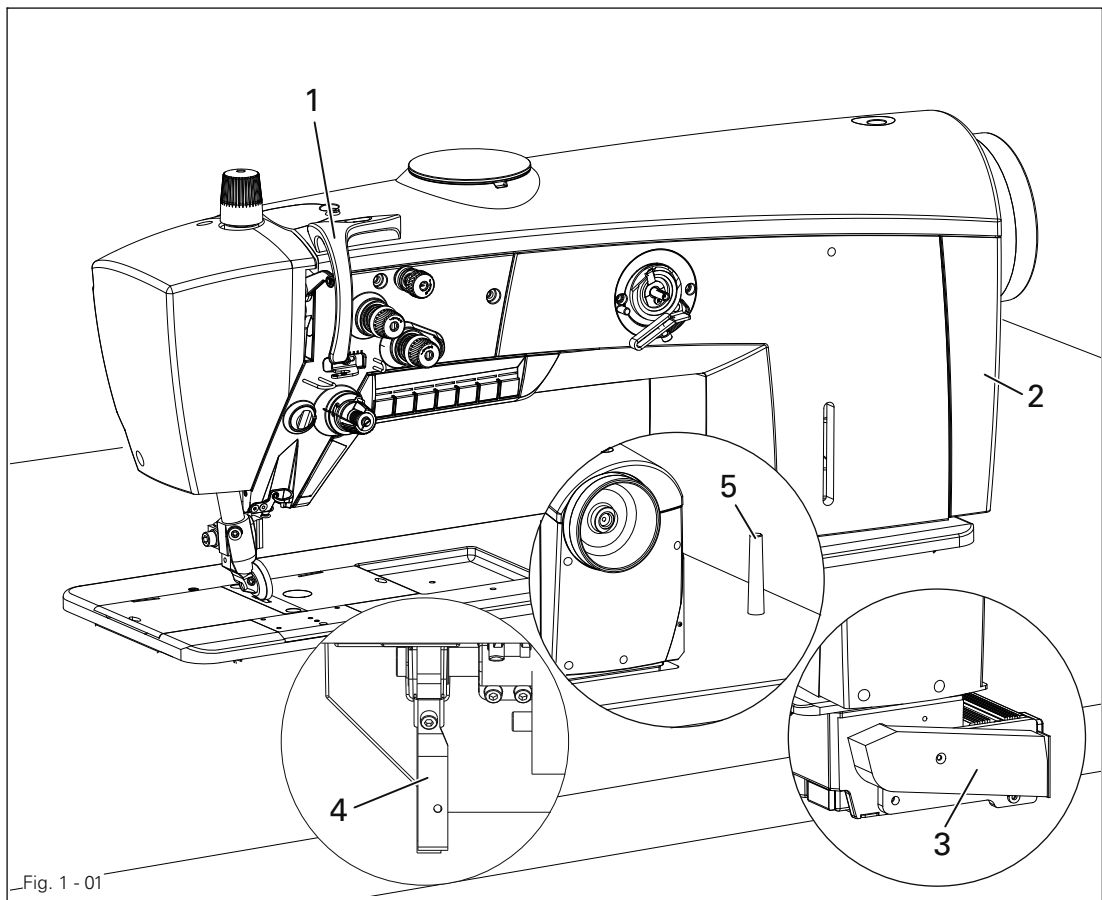

Fig. 1 - 01



Do not run the machine without take-up lever guard 1!
Danger of injury by moving take-up lever!



Do not operate machine without cover 2 and belt guard 3!
Risk of injury from moving parts!



Do not operate the machine without tilt lock 4!
Danger of crushing between sewing head and table!



Do not operate the machine without support 5! Danger due to top-heavy sewing head! Machine can tip over backwards when tilted!

2

Proper use

The PFAFF 2521 is a high-speed, single-needle sewing machine with forward- and reverse-feeding feed wheel and roller presser, as well as needle feed.

These machines are used for sewing lockstitch seams in the leather and upholstery industries.



Any and all uses of this machine which have not been approved of by the manufacturer are considered to be inappropriate! The manufacturer cannot be held liable for any damage caused by the inappropriate use of the machine! The appropriate use of the machine includes the observance of all operational, adjustment, maintenance and repair measures required by the manufacturer!

Specifications

3 Specifications *

3.01 PFAFF 2521

Stitch type:301 (lockstitch)

Needle system: 134-35

Model: A, B, C

Needle thickness in 1/100 mm:

Model A: 70

Model B: 100

Model C: 130

Stitch length max.:5,0 mm

Thread thickness max. (Synthetiks):

Model A: 60/3▲

Model B: 40/3▲

Model C: 15/3▲

Clearance under roller presser:7 mm

Clearance width:345 mm

Clearance height:290 mm

Max. speed:

Model A + B 3500 spm ♦

Model C 2000 spm ♦

Noise data:

Noise emission level at workplace with a sewing speed of 2800 spm: $L_{pA} < 80$ dB(A)■

(Noise measurement in accordance with DIN 45 635-48-A-1, ISO 11204, ISO 3744, ISO

Connection data:

Operating voltage: 230 V ± 10%, 50/60 Hz

Max. power consumption: 1.2 kVA

Fuse protection: 1 x 16 A, inert

Leakage current: ≤ 5 mA **

Net weight of sewing head: approx. 72 kg

Gross weight of sewing head: approx. 82 kg

* Subject to alteration

** Due to the use of network filters there is a nominal leakage current of ≤ 5 mA.

♦ Dependent on material, work operation and stitch length

▲ or similar strengths of other types of thread

■ $K_{pA} = 2,5$ dB

3.02 Machine equipment and options

PFAFF 2521	
Vetical hook, large	●
Thread trimmer (-900/81), < 13 mm rest thread	●
Presser foot lift (-910/04), electropneumatic	●
Automatic backtacking (-911/35), electropneumatic	●
2 preselectable thread tensions, one can be switched on electropneumatically by hand switch	●
Oil level on display, with warning light on machine head	●
Roller-presser pressure, manually adjustable	●
DC-motor P 321	●
Control panel - BDF - S3	●
Integrated multiple switch on machine head + programmed multi switch	●
Integrated LED sewing lamp on sewing head, dimmable	●
Bobbin thread winding device	●
Remaining bobbin thread recognition function by stitch counting with LED display	●
Bobbin thread monitoring with thread detection (-926/06)	○
Monitoring of slide plate / Safety device for the start	○
Safety coupling	●

● = Standard, ○ = Option

4

Disposal of Machine

- Proper disposal of the machine is the responsibility of the customer.
- The materials used for the machine are steel, aluminium, brass and various plastic materials. The electrical equipment comprises plastic materials and copper.
- The machine is to be disposed of according to the locally valid pollution control regulations; if necessary, a specialist is to be commissioned.



Care must be taken that parts soiled with lubricants are disposed of separately according to the locally valid pollution control regulations!

5 Transportation, packing and storage

5.01 Transportation to customer's premises

The machines are delivered completely packed.

5.02 Transportation inside the customer's premises

The manufacturer cannot be made liable for transportation inside the customer's premises nor to other operating locations. It must be ensured that the machines are only transported in an upright position.

5.03 Disposal of packing materials

The packing materials of this machine comprise paper, cardboard and VCE fibre. Proper disposal of the packing material is the responsibility of the customer.

5.04 Storage

If the machine is not in use, it can be stored as it is for a period of up to six months, but it should be protected against dust and moisture.

If the machine is stored for longer periods, the individual parts, especially the surfaces of moving parts, must be protected against corrosion, e.g. by a film of oil.

6 Explanation of symbols

In this instruction manual, work to be carried out or important information is accentuated by symbols. These symbols have the following meanings:



Note, information



Cleaning, care



Lubrication

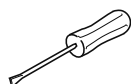

Maintenance, repairs, adjustment, service work
(only to be carried out by technical staff)

7 Controls

7.01 On/off switch / Sewing lamp switch (option)

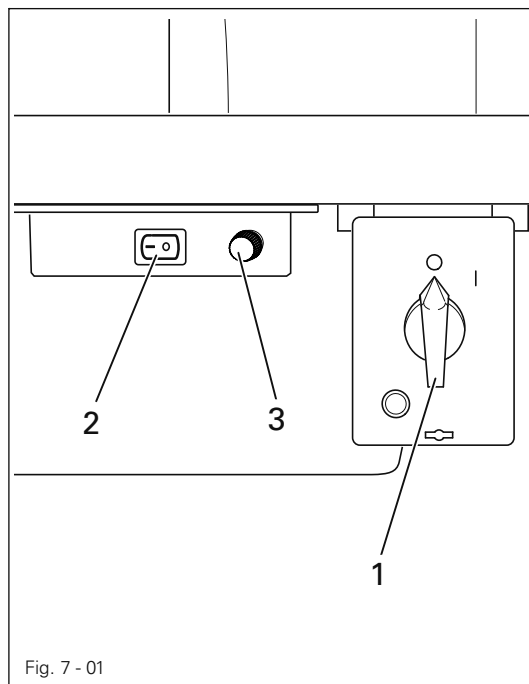

- To switch the control system of the machine on or off, turn main switch 1.
- Switch the sewing lamp, which is integrated in the machine head, on or off by operating switch 2.
- Switch 3 regulates the brightness of the sewing lamp.

7.02 Pedal

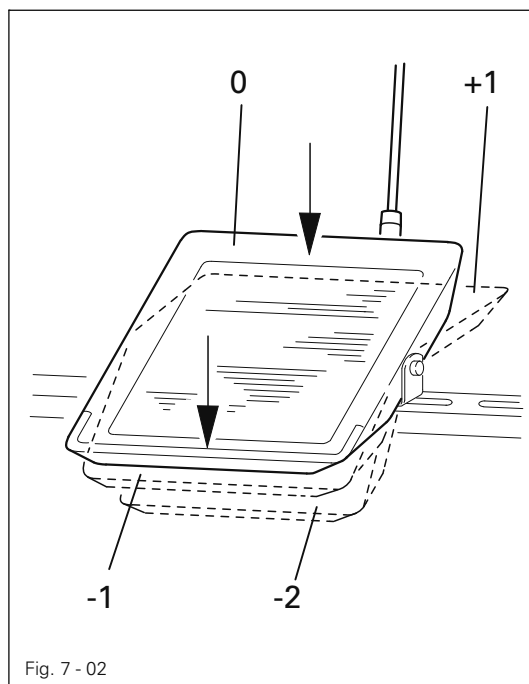

- With the on/off switch on
 - 0 = Machine stop
 - +1 = Sew
 - 1 = Raise roller presser
 - 2 = Trim thread

7.03 Keyboard on machine head

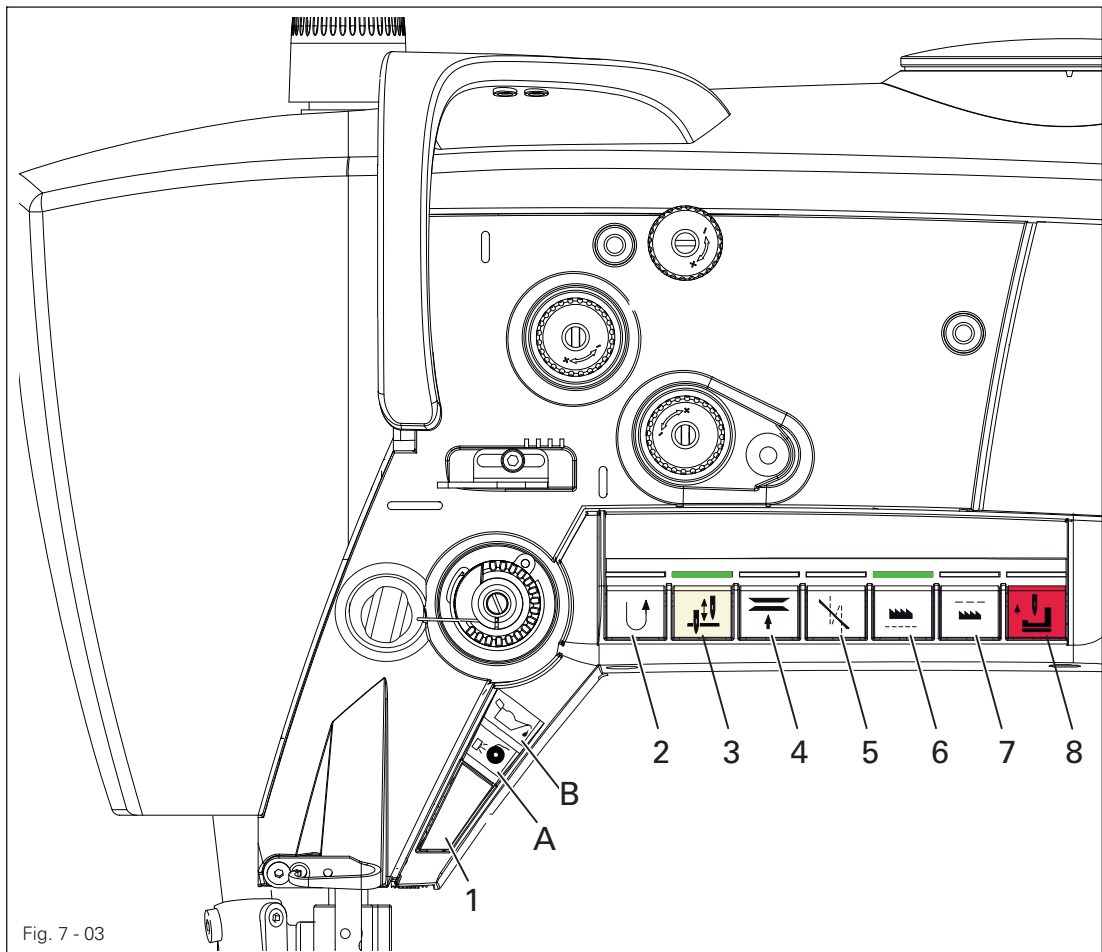

- The machine has a keyboard with 8 keys to activate different functions.
- In the keys 2 – 7 there are yellow LEDs. These shine when the respective function has been allocated to key 1.
- Green LEDs are located above the keys 2 - 7. These shine when the function has been activated.
- Above key 1 there are two symbol lamps.
Lamp A indicates the status of the bobbin thread control.
Lamp B shines when the minimum level of the oil supply has been reached.
- When the keys 1 – 8 are operated, the functions listed below are carried out.

Key 1: The functions of the keys 2 - 7 can be allocated to this key.
To program key 1, simultaneously press one of the keys 2 - 7 and key 1 for approx. **3 seconds**. The function of the selected key is taken over and the yellow LED in this key lights up



Key 2: Reverse sewing or intermediate backtacks during the seam (Standard)



Key 3: Needle position change
In setting **203**, this button can be allocated to the following functions:
Set value 1 = Needle raised without trimming
 3 = Single stitch



Key 4: Additional thread tension ON/ OFF.



Key 5: Bartack suppression for one bartack



Key 6: Half stitch
The machine will carry out one stitch of half the set stitch length when this button is pressed.



Key 7: Singel stitch
The machine will carry out one additional stitch of the set stitch length when this button is pressed.



Key 8: EMERGENCY KEY.
Needle is raised without trimming, the thread clamp is opened, the thread tension is released, the presser foot raised and the motor start inhibitor activated (diode above the key lights up red)..



If the "scroll" key on the control panel is pressed, the motor start inhibitor is deactivated again.

7.04 Lever for raising the roller presser

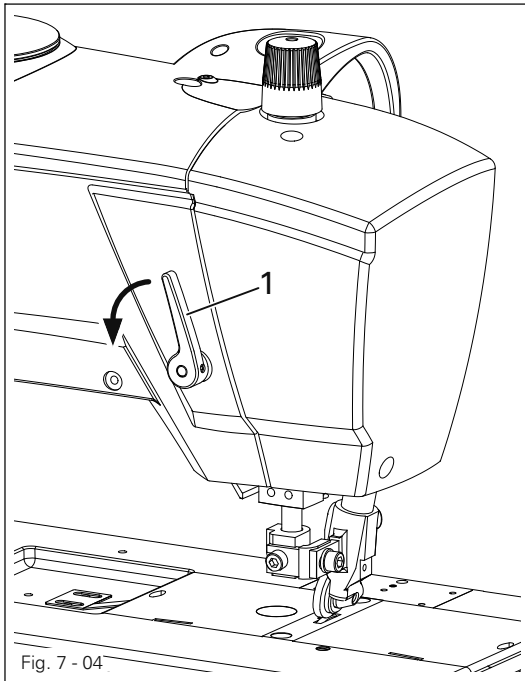

- Raise the roller presser by turning lever 1.

7.05 Swivel out the roller-presser

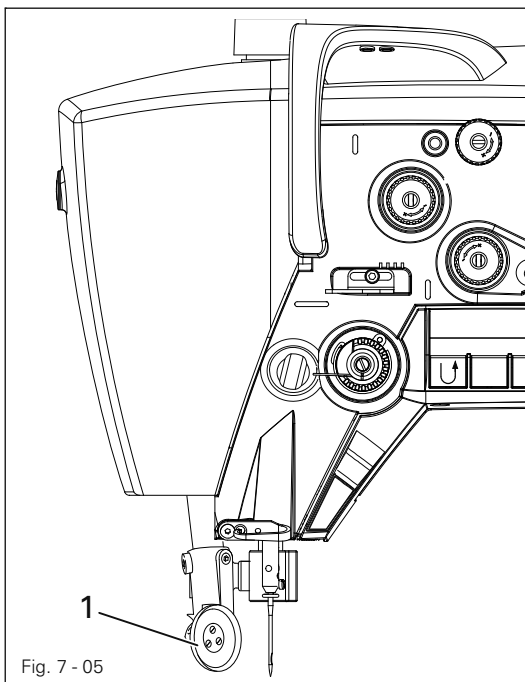

- In the raised position the roller-presser 1 can be swivelled out by gently pulling downwards.

7.06 Knee lever

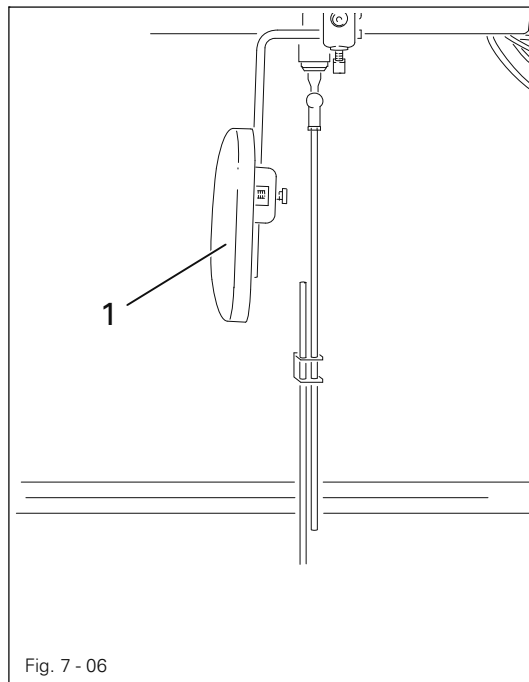

Fig. 7 - 06

- Operate knee lever 1 to raise the roller presser.

7.07 Knee switch

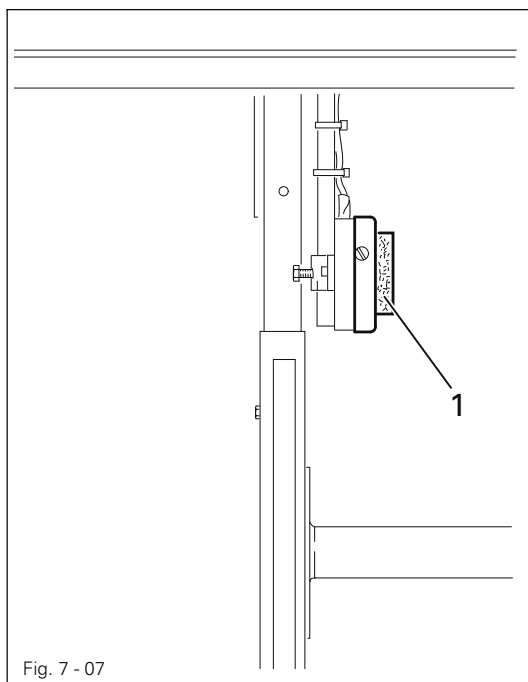

Fig. 7 - 07

- In the programmed sewing mode it is possible to switch to the next seam section with knee switch 1.



The function of knee switch 1 must be switched on with the control panel (see chapter 9.02 Programmed Sewing)

7.08 Bobbin thread monitoring with stitch counting

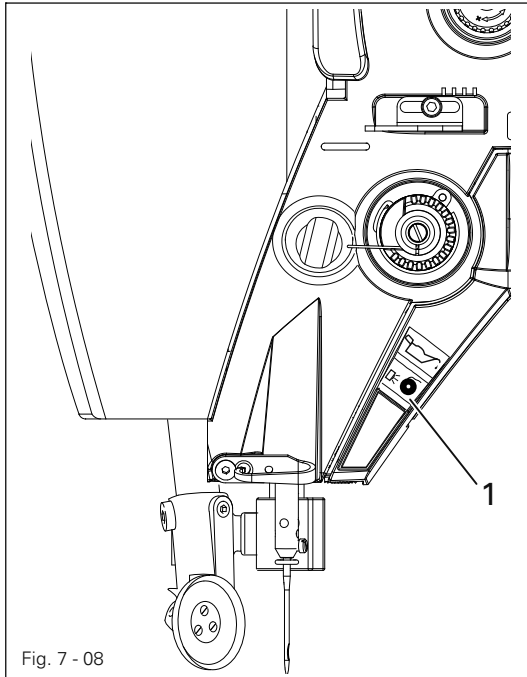

- About 100 stitches before reaching the preset number of stitches, key 1 flashes.
- After the thread has been trimmed and the bobbin changed, the stitch counting begins anew.
- Pre-setting see chapter 8.08.

7.09 Bobbin thread supply monitor (option -926/06)

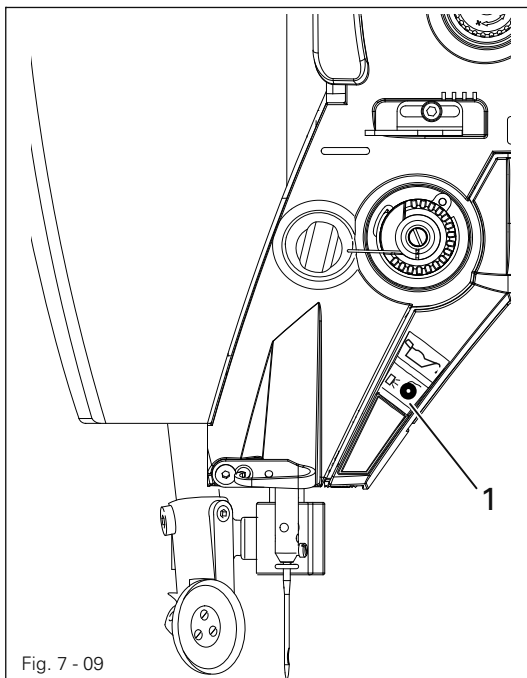

- After reaching the set amount of remaining thread, key 1 starts to flash. It is possible to sew to the end of the seam being sewn.



After the thread has been trimmed, the signal "WARNING 2 - BOBBIN" appears on the display. After the bobbin has been changed, a random key must be pressed before it is possible to continue sewing.

- Pre-setting see chapter 8.09.

7.10 Control panel

The control panel is used to display and call up the machine functions for setting up and for sewing operation, for entering parameter values and for reading error messages and service settings.

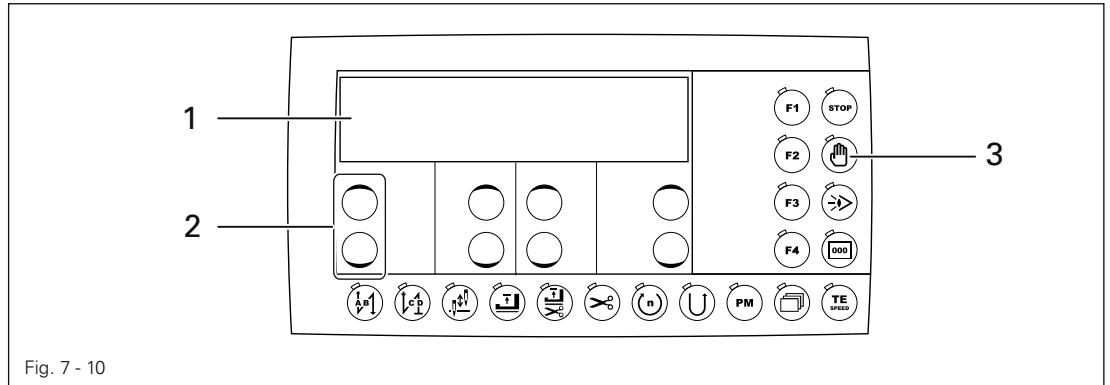

Fig. 7 - 10

The control panel has the following control and display elements:

- The display screen 1 consists of a two-line, alphanumerical LCD display with 16 symbols per line and is used to show relevant information and selection parameters.
- The plus-minus keys 2 are used to select or alter the functions and parameters shown on the display.
- The function keys 3 are used to switch the relevant function on or off. Activated functions are shown in each case by an illuminated LED.

7.10.01 Symbols on the display



In addition to texts and set values, the following symbols are shown on the display.

The symbols only appear in the programmed sewing mode, see Chapter 9.02 Programmed Sewing.

	Current program number
	Current seam sector
	Seam input via "teach-in"
	Deleting a program
	Current program number
	Current seam sector
	Stitch length (forward feed) for the roller-presser
	Stitch length (forward feed) for the feed wheel
	SD memory card
	Machine memory

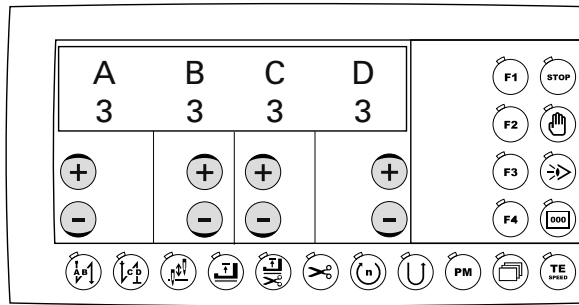
7.10.02 +/- keys









-  The selection and changing of setting values (e.g. entering the backtick stitches) can be carried out using the corresponding +/- keys. By pressing and holding the relevant +/- key, the numerical value displayed above it is altered slowly. If the +/- key is pressed longer, the numerical value changes more quickly.
- 

7.10.03 Function keys

An activated function is always shown by the corresponding illuminated LED.

Function descriptions in detail:

-  **Start backticks**
 - If this key is pressed, the backtick function at the beginning of the seam (start backticks) is switched on or off. In manual sewing the number of forward stitches (A) or reverse stitches (B) for the start backticks can be changed respectively by pressing the +/- key underneath. To convert from double backtick to single backtick, reset the number of stitches (A) for the corresponding seam section.
-  **End backticks**
 - If this key is pressed, the backtick function at the end of the seam (end backticks) is switched on or off. In manual sewing the number of reverse stitches (C) or forward stitches (D) can be changed respectively by pressing the +/- key underneath. To convert from double backtick to single backtick, reset the number of stitches (D) for the corresponding seam section.
-  **Needle position raised at sewing stop**
 - If this key is pressed, the "needle position raised at sewing stop" function is switched on or off. If the function is turned on, the needle positions at t.d.c. after sewing stop.
-  **Foot position after stop**
 - If this key is pressed, the "foot position after sewing stop" function is switched on or off. If the function is turned on, the foot position is raised after sewing stops.
-  **Foot position after trimming**
 - If this key is pressed, the "foot position raised after thread trimming" function is switched on or off. If the function is turned on, the foot position is raised after thread trimming.
-  **Thread trimming**
 - If this key is pressed, the "thread trimming" function is switched on or off.

- 

Speed

 - With this key, a maximum speed for each seam zone can be defined which is only activated in the corresponding seam zone.

- 

Reverse sewing (only for programmed sewing)

 - If this key is pressed, the reverse sewing function is switched on or off.

- 

Program interrupt

 - If this key is pressed, the automatic process of a sewing program is interrupted, the stitch count is switched off and some procedures varied.

- 

Stop

 - In programmed sewing, the machine stops automatically at the end of a seam section when the function is turned on.



- 

Photo cell

 - If this key is pressed, the corresponding function is switched on or off.
If the function is turned on, the machine moves to the next seam zone via photo cell.

- 

Stitch count (only for programmed sewing)

 - If this key is pressed, the corresponding function is switched on or off. If the function is turned on, the machine moves to the next seam zone after sewing the number of stitches entered.

- 

TE/Speed

 - If this key is pressed once, the speed limit for the programmed sewing mode is activated.
 - If this key is pressed twice (within 5 seconds) the machine changes from sewing mode to stitch input.

- 

Scrolling

 - If this key is pressed, the input menus on the display are scrolled through.

- 

PM / mode

 - If this key is pressed, the programmed sewing function is switched on or off. The parameters related to the program are shown in the alpha-numeric part of the display.

- 

F1

 - If this key is pressed, the placed stitch position in programming / learning when sewing begins is switched on or off. The corresponding needle position is set using the key and by turning the handwheel.

- 

F2

 - No function assigned

- 

F3

 - If this key is pressed, moving to the next seam zone using the knee switch is switched on or off.

- 

F4

 - If this key is pressed, the next backtack is not stitched. If the key is pressed twice, the next two backtacks are suppressed.

8 Preparation



All regulations and instructions in this Instruction Manual are to be observed!
Special attention is to be paid to the safety regulations!



All preparation work is only to be carried out by appropriately trained personnel.
Before all preparation work, the machine is to be separated from the electricity supply by removing the plug from the mains or switching off the On/Off switch!

8.01 Inserting the needle

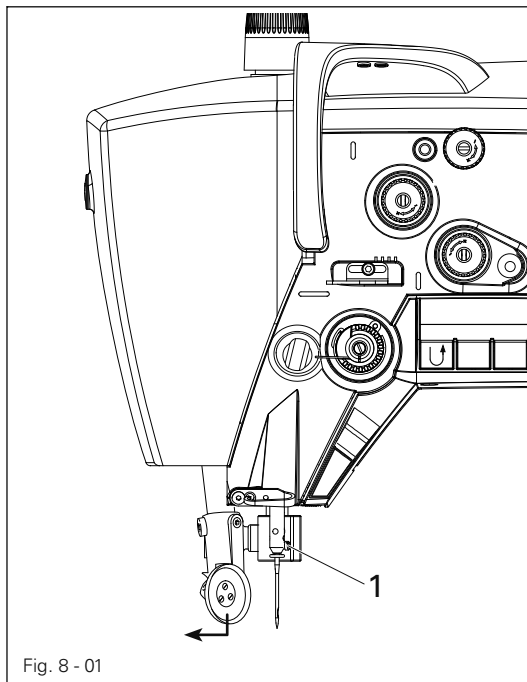

Switch off the machine!
Danger of injury due to unintentional starting of the machine!



Only use needles from the system intended for the machine, see Chapter 3 Specifications.

- Set needle bar at top position.
- Swing out the roller presser.
- Loosen screw 1.
- Push the needle fully in (the long needle groove must face to the left)
- Tighten screw 1

8.02 Winding the bobbin thread, regulating the winder tension

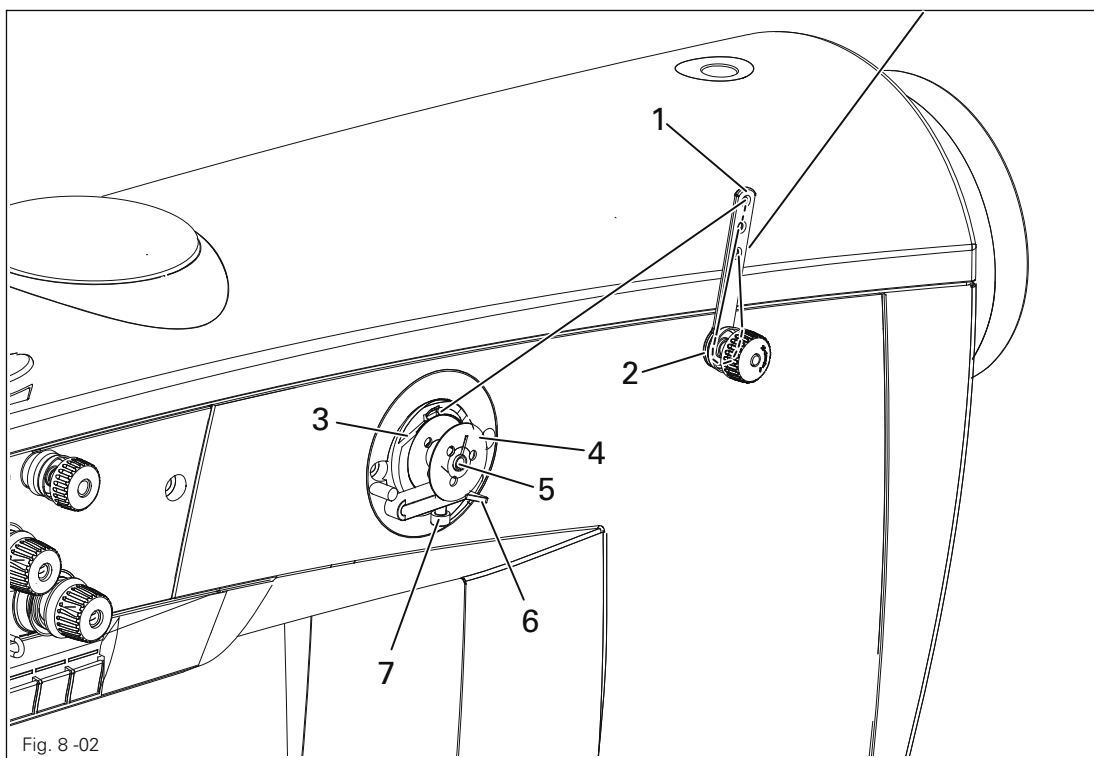

- Draw the thread from the reel stand through guide hole 1 into the bobbin winder tension unit 2 and then behind the thread clamp 3.
- Cut off the thread in thread clamp 3. The thread is retained.
- Place empty bobbin 4 on the bobbin winder spindle.
- To switch on the bobbin winder, push up lever 6.



The bobbin is wound during sewing.

- The bobbin winder stops automatically, when the bobbin 4 is filled sufficiently.
- Remove full bobbin 4 and cut off the thread in thread clamp 3.
- The tension of the thread on bobbin 4 can be adjusted on the bobbin winder tension unit 2.
- The volume of thread on bobbin 4 can be adjusted with screw 7.

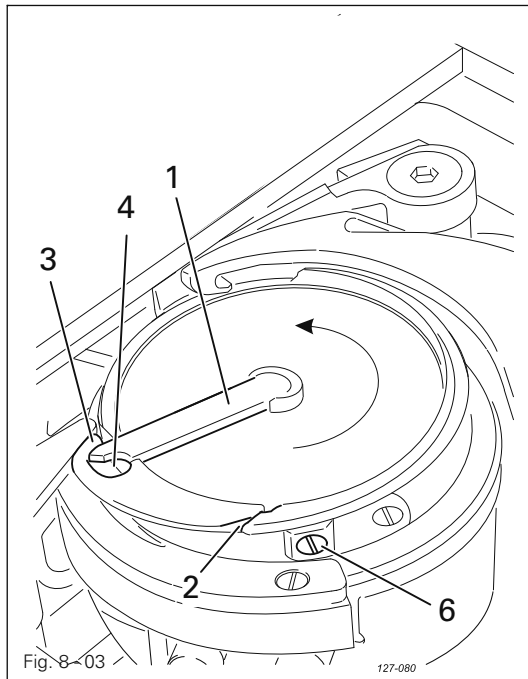

Switch off the machine!
Danger of injury due to unintentional starting of the machine!

- Set take-up lever at its top position.
- Open bed slide, lift latch **1** and take out the bobbin. Place the filled bobbin into the hook so that the bobbin turns as shown by the arrow when the thread is pulled.
- Close latch **1** again.
- Pull the thread through slot **2**, around stop **3** and into hole **4**. Close the bed slide again.
- Regulate the bobbin-thread tension by turning screw **5**.



Do not run the machine with the bed slide open.
Danger of injury by moving parts.

8.04 Threading needle thread and regulating its tension

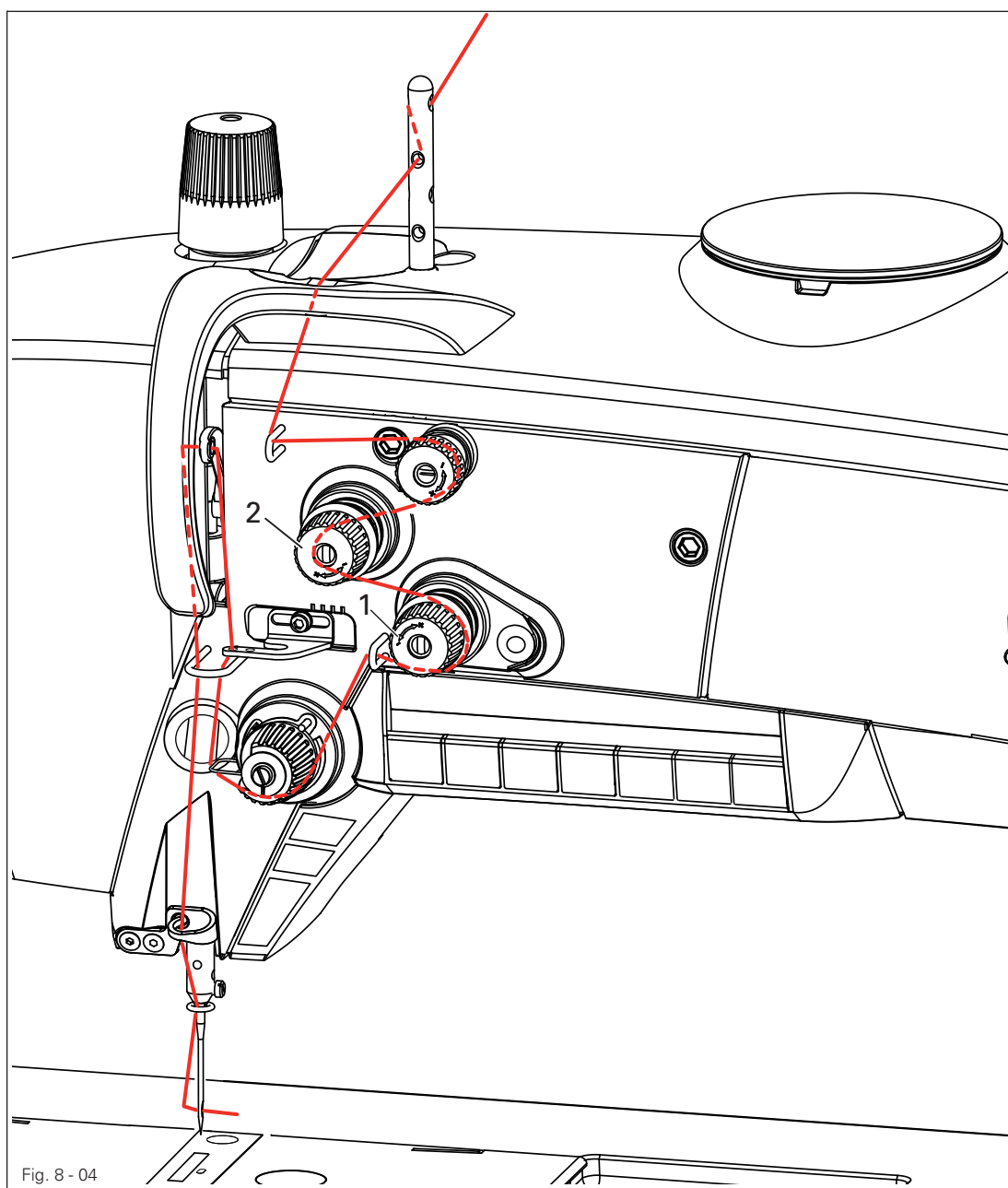

Switch off the machine!
 Danger of injury due to unintentional starting of the machine!

- Thread the needle thread as shown in Fig. 8 - 04.
- Regulate the needle-thread tension by turning milled screw 1 or 2.



8.05 Setting the stitch length

The stitch length is defined by setting the forward feeds of the roller-presser and feed wheel. For the incorporation of fullness, the forward feed on the roller-presser must be larger or smaller than the forward feed of the feed wheel.

8.05.01 Entering the standard stitch length

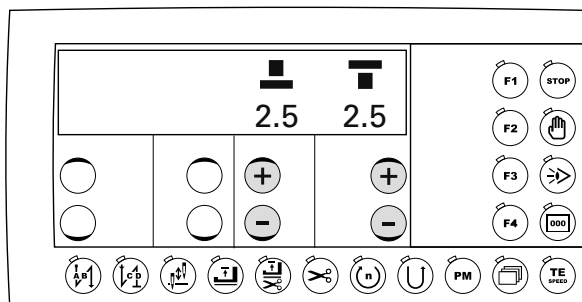
- Switch machine on.
- Once the machine is switched on, the current stitch length values for the roller-presser and feed wheel are shown in the display.



- 
 - Set the stitch length (forward feed) for the roller-presser by pressing the corresponding +/- key.
- 
 - Set the stitch length (forward feed) for the feed wheel by pressing the corresponding +/- key.





The maximum difference between the forward feed roller-presser and feed wheel is 1mm.

8.05.02 Entering a second stitch length or fullness

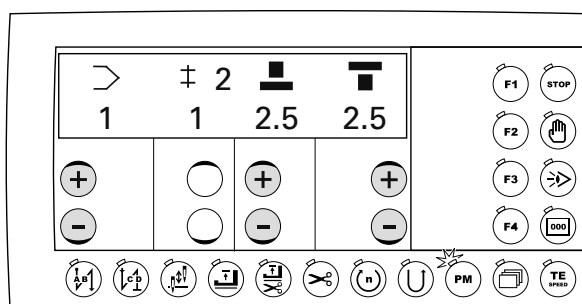
Using the **PM** key, a second stitch length or fullness setting can be defined in addition to the standard stitch length. In programmed sewing (LED is on), switching between both settings is carried out by pressing the knee switch.



- Switch machine on.
- Press the **PM** key to enter programmed sewing (**LED lights up**).
- 
 - Select program number (1 or 2) by pressing the +/- key.
- Sew 1-2 stitches and press the knee switch, see also Chapter 7.06 Knee switch.
- 
 - Set the stitch length (forward feed) for the roller-presser by pressing the corresponding +/- key.
- 
 - Set the stitch length (forward feed) for the feed wheel by pressing the corresponding +/- key.

8.06 Entering the start and end backtacks

- Switch machine on.

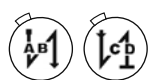
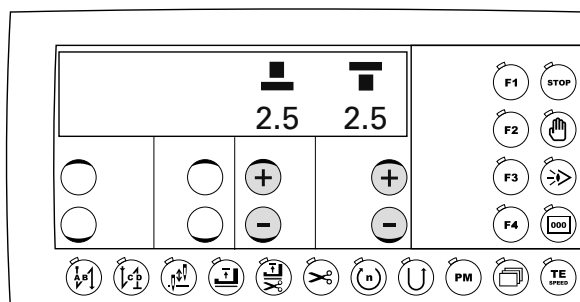

- Press the **start and/or end backtack** keys to switch on the corresponding function. (LED lights up)



- Press the **scrolling** key to change the input menu for start and end backtacks.

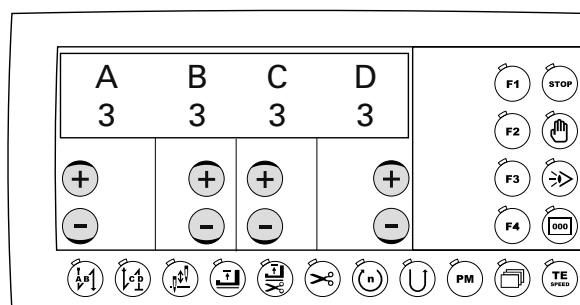

- A** ● Select the desired value for the number of start backtack forward stitches (A) by pressing the **+/-** key.
- B** ● Select the desired value for the number of start backtack backward stitches (B) by pressing the **+/-** key.
- C** ● Select the desired value for the number of end backtack backward stitches (C) by pressing the **+/-** key.
- D** ● Select the desired value for the number of end backtack forward stitches (D) by pressing the **+/-** key.



- By pressing the **scrolling** key, the input menu for stitch length is called up again.

Setting up

8.07 Entering/changing the template code

8.07.01 Entering the template code

- Switch machine on.

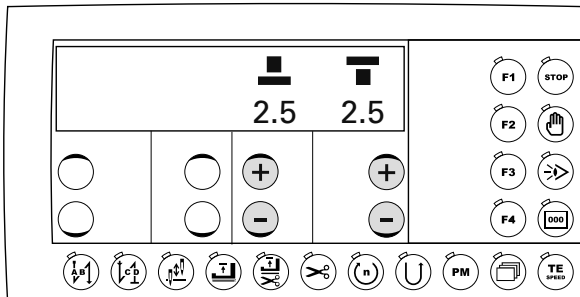

- 2x  ● Press the TE/Speed key twice (LED lights up).

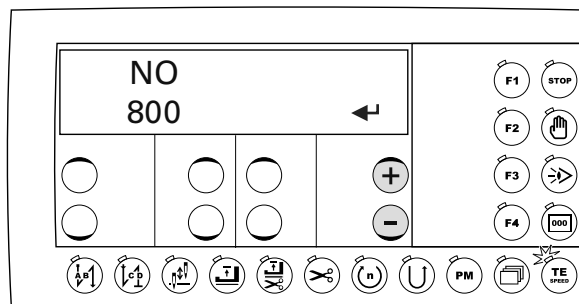
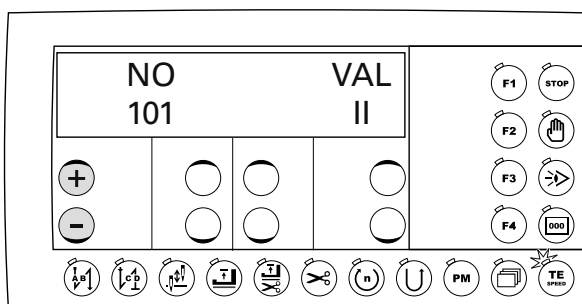

- Select parameter group "800" by pressing the +/- key.
- ← ● Confirm selection by pressing "+" on the +/- key on the right.

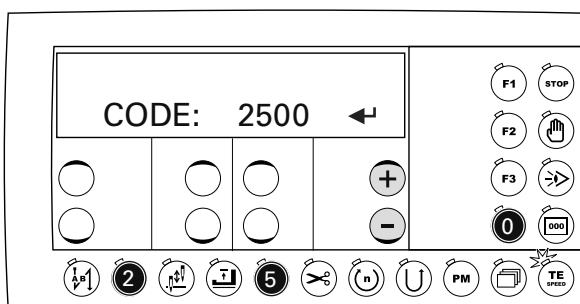

- Enter template code by pressing the corresponding buttons (the factory setting is code "2500").
- ← ● Finish entering the template code by pressing the corresponding +/- key.



The code input remains saved until the machine is switched off by the main switch. Provided that the machine is not turned off, all parameters can be accessed without re-entering the template code.

8.07.02 Changing the template code

- Switch machine on.

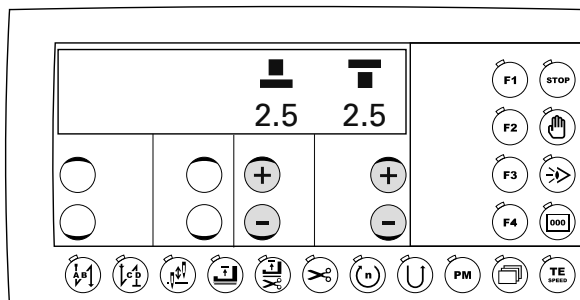

- 2x  ● Press the TE/Speed key twice (LED lights up)

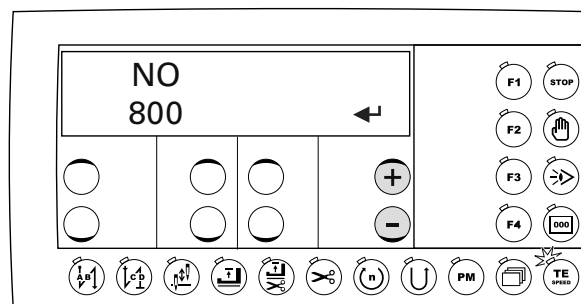
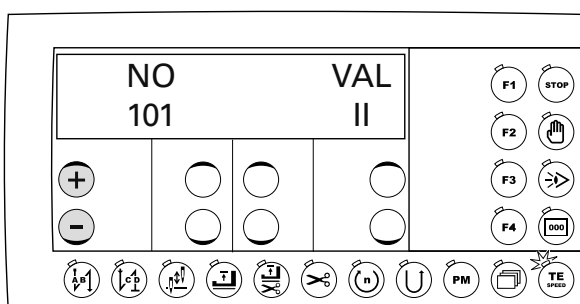

- Select parameter group "800" by pressing the +/- key.
- ← ● Confirm selection by pressing "+" on the +/- key on the right.
- Input old code number by pressing the relevant keys.
- Select parameter "810" by pressing the +/- key.

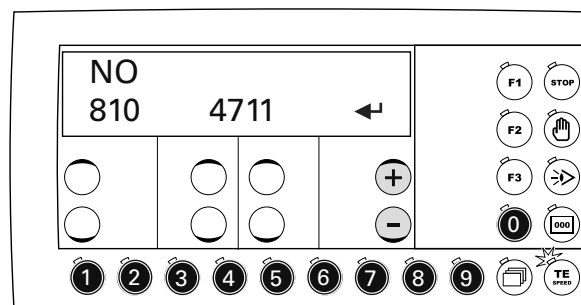
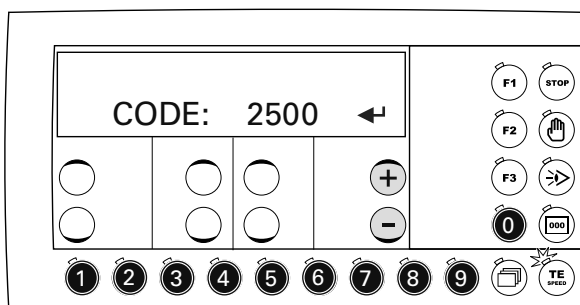

- ← ● Enter the new code.
-  ● End the input by pressing the TE key. The new entered code is saved and the sewing mode is called up.



Provided that the machine is not turned off, all parameters can be accessed without re-entering the template code.

Remember the code!

Without the corresponding code, protected functions cannot be called up! In this case request support from the PFAFF service centre.

8.08 Setting the stitch counting function for the bobbin thread control



The stitch counting function can only be activated when parameter "104" is set at the value "1".

- Switch machine on.

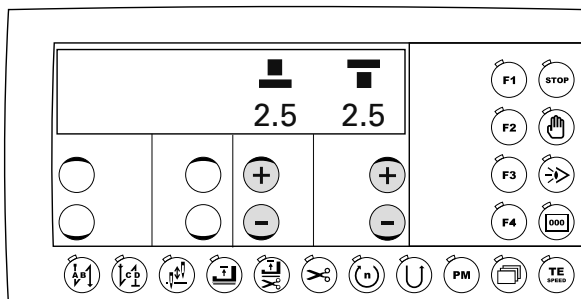

2x



- Press the TE/Speed key twice (LED lights up)
- Select parameter group "100" by pressing the left +/- key.

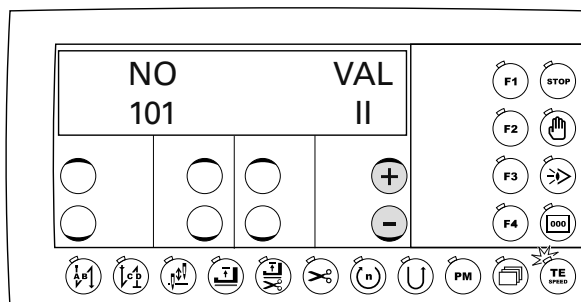

- Select parameter "105" by pressing the +/- key.

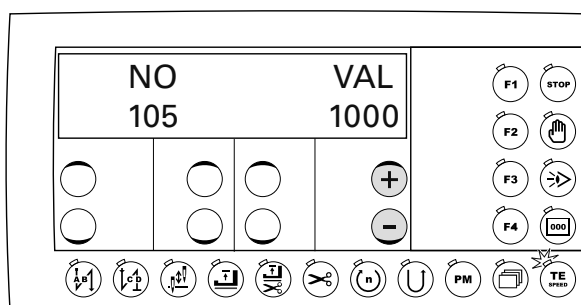

VAL ● Set the number of stitches which can be sewn after recognition by the bobbin thread monitor, by pressing the +/- key.



- End the input by pressing the TE/Speed key. The entered value is saved and the sewing mode is called up.

8.09 Setting the stitch counting function for the bobbin thread supply monitor (on machines with sub-class -926/06)



The stitch counting function can only be activated when parameter "104" is set at the value "2".

- Switch machine on.

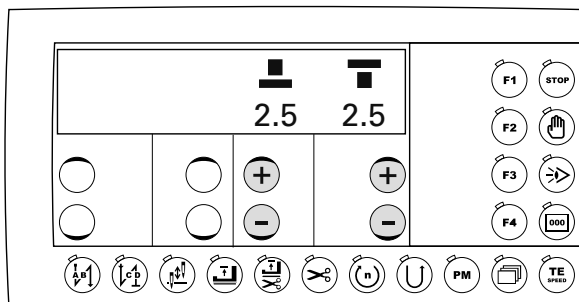

- Press the TE/Speed key twice (LED lights up)
- Select parameter group "100" by pressing the left +/- key.

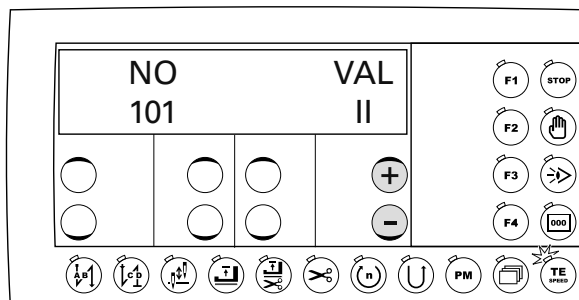

- Select parameter "106" by pressing the +/- key.

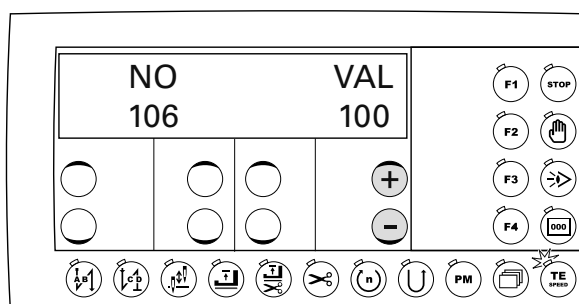

- VAL ● Set the number of remaining stitches, which can still be sewn according to the bobbin thread supply monitor (depends on the thread size) by pressing the corresponding +/- key.



- End the input by pressing the TE/Speed key. The entered value is saved and the sewing mode is called up.

8.10 Inserting and removing the SD-memory card

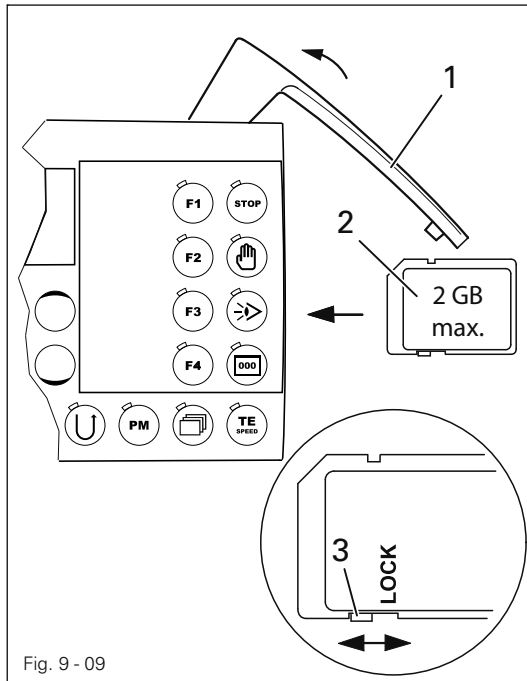

Inserting the SD-memory card

- Open cover 1.
- Insert SD-memory card 2 into the card slot with the label at the front.
- Close cover 1 again.



Use only memory cards formatted FAT 16

Removing the SD-memory card

- Open cover 1.
- Press the edge of the SD-memory card 2 lightly – the SD-card is ejected.
- Close cover 1 again.



By moving slide 3 it is possible to activate (position "LOCK") or deactivate the write protection function of the SD-memory card. To store, process or delete data on the SD-memory card, the write protection function must be deactivated.

9 Sewing

In sewing mode all settings relevant for the sewing operation are shown in the display. Functions can be switched on or off by pressing the key, values for start and end backtacks or placed stitch can be altered directly.

In this mode a difference is made between manual sewing and programmed sewing.

The "PM" button is used to switch between manual sewing (**LED off**) and programmed sewing (**LED on**).



The fixed programs, which are programmed in machine memory, are stored under the program numbers 1-2. The program numbers 3-99 can be assigned with freely programmable seams.

9.01 Manual sewing

After the machine has been switched on and the selection of manual sewing pressed by the PM key, the display appears for entering the stitch length, see also Chapter 8.05 Changing the stitch length.

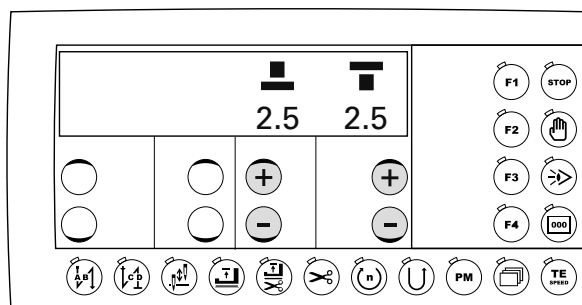

If the backtack function is switched off, the display appears for entering the backtack values, see also Chapter 8.08 Entering the start and end backtacks.



To switch between the displays, press the **scrolling** key.

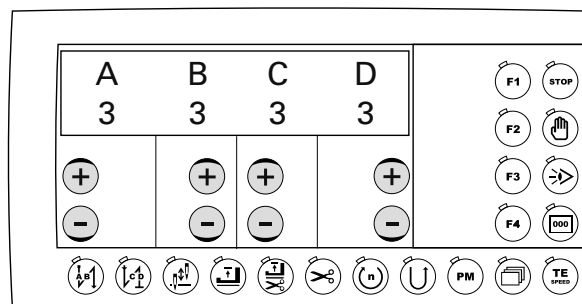

Further functions in manual sewing, see also Chapter 7.10.3 Function keys:



Backtack suppression



Raise roller-presser on/off



Start backtack on/off



Raise roller-presser after thread trimming on/off



End backtack on/off



Thread trimming on/off



Raise needle position on/off

Sewing is carried out using the pedal function, see also Chapter 7.02 Pedal.

9.02 Programmed sewing

In programmed sewing a difference is made between fixed programs (program numbers 1 and 2) and freely programmable sewing programs (program numbers 3-99).

The fixed programs are used for the quick and easy production of seams with different number of stitches or fullness. The respective 2 or 3 seam sections are switched using the knee switch function, see also Chapter 7.06 **Knee switch**. The fixed programs are also designed as running programs and can be concluded by the pedal function, see also Chapter 7.02 **Pedal**.

The freely programmable sewing programs (program numbers 3 to 99) can be entered, altered or deleted if necessary, see Chapter 10 **Input**.



After the machine has been switched on and the programmed sewing mode has been selected with the **PM** key, the display appears for selecting the program number, seam section and number of stitches.

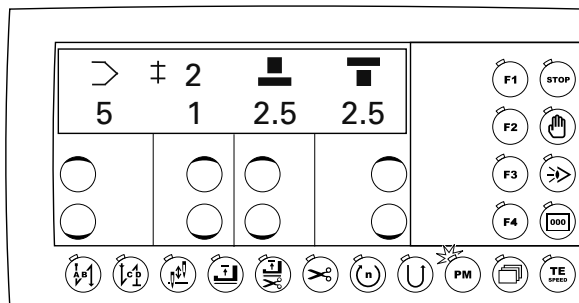



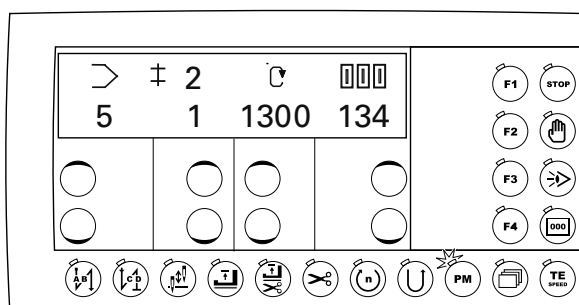









If other functions are switched on, for example backtack functions, maximum seam section speed or stitch count, the **scroll key** can be used to switch between other menu displays, for example, for entering the values for the maximum speed in the corresponding seam section and stitch count.



Entering the values is carried out by pressing the corresponding **+/- key**.

Further functions in programmed sewing, see also Chapter 7.10.3 Function keys:

 F1	Placed stitch function on/off		Thread trimming on/off
 F3	Knee switch function on/off		Seam section speed on/off
 F4	Backtack suppression on/off		Reverse sewing direction on/off
	Start backtack on/off		Program interrupt
	End backtack on/off		Stop on/off
	Raise needle position on/off		Photo cell on/off
	Raise roller-presser on/off		Stitch count on/off
	Raise roller-presser after thread trimming on/off		

Sewing is carried out using the pedal function, see Chapter 7.02 Pedal.

9.03 Program interrupt

If the course of a seam program is interrupted (e.g. a broken thread), the program interrupt function must be called up.



- After pressing the **program interrupt** key, the seam program course is interrupted. Sewing can continue manually, and the values for the stitch length from the current seam program are taken over.

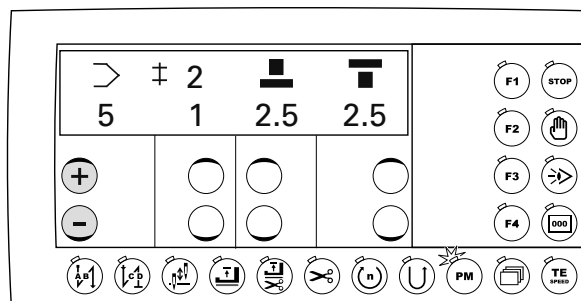

- ‡ ● The seam zone can be selected by pressing the corresponding +/- key, in which the seam program should be continued.



- By pressing the **program interrupt** key again, the machine moves into the selected seam zone and the programmed sewing function is continued.

9.04 Error messages

When a fault occurs the display shows "ERROR" together with an error code, as shown in the following example. An error message can be caused by incorrect set up, faulty elements or overloading.

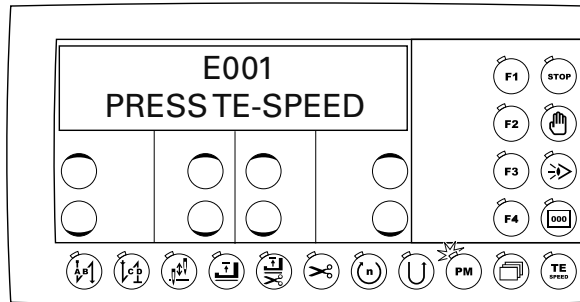

- Correct the fault.
- If necessary cancel fault correction.



For a description of errors see Chapter 1.08 in the Settings Manual, **Error Codes and Description**.

10 Input

10.01 Overview of functions in input mode



By pressing the **TE/Speed** key twice, the input mode is called up. Within input mode, a difference is made between parameter inputs and seam program inputs.



After activation of the input mode, the **PM** button is used to enter into the seam program input.

10.01.01 Overview of parameter functions



Select parameter group



100 (Operator level)

200 (Mechanic level)

300 (Sewing motor function)

400 (Times)

500 (Counter and revolution speed)

600 (Service)

700 (Sewing motor)

800 (Access authorisation)



Calling up the seam program input, see Chapter 10.01.02 Overview of seam program input



More detailed descriptions of parameter functions, see Settings Manual.

10.01.02 Overview of seam program input

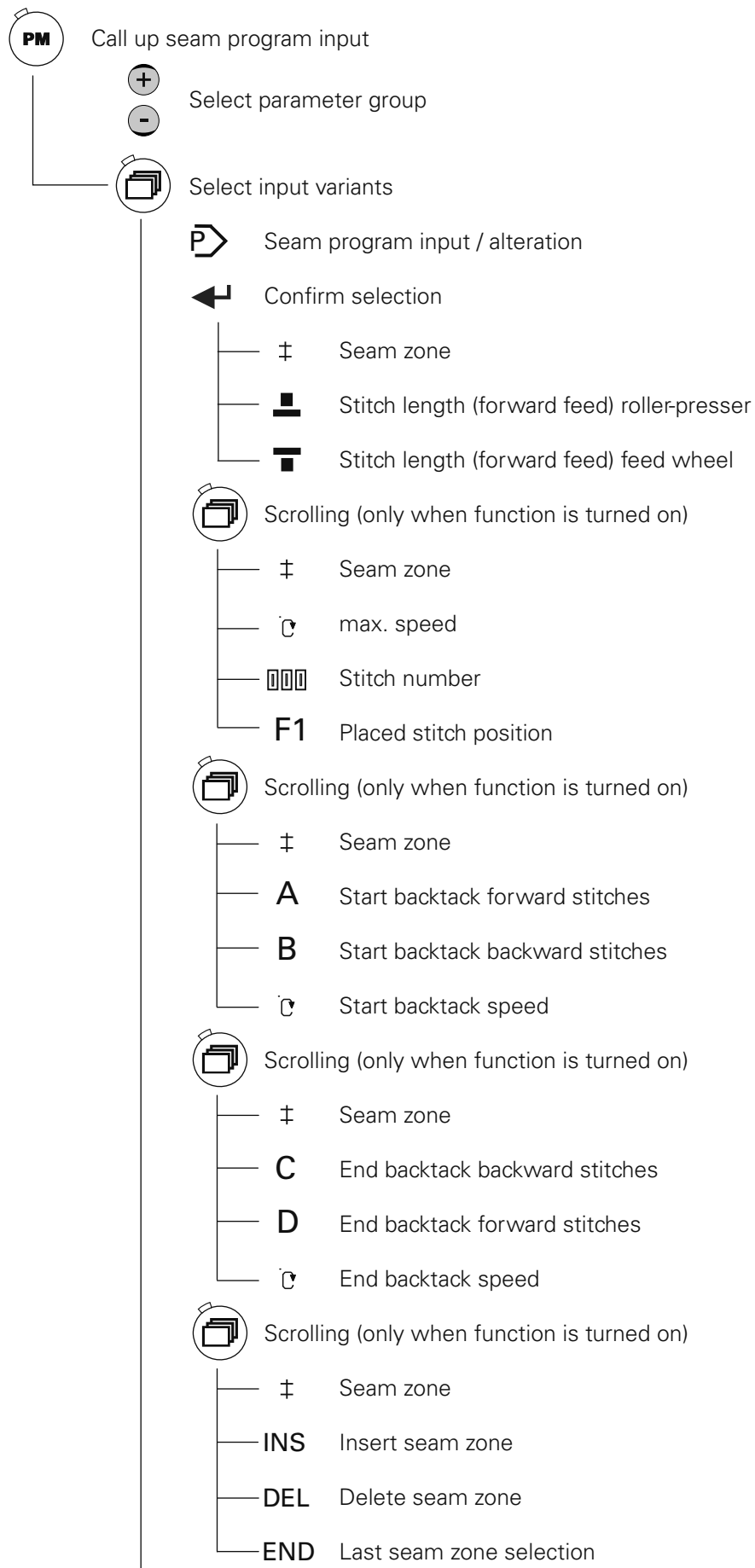

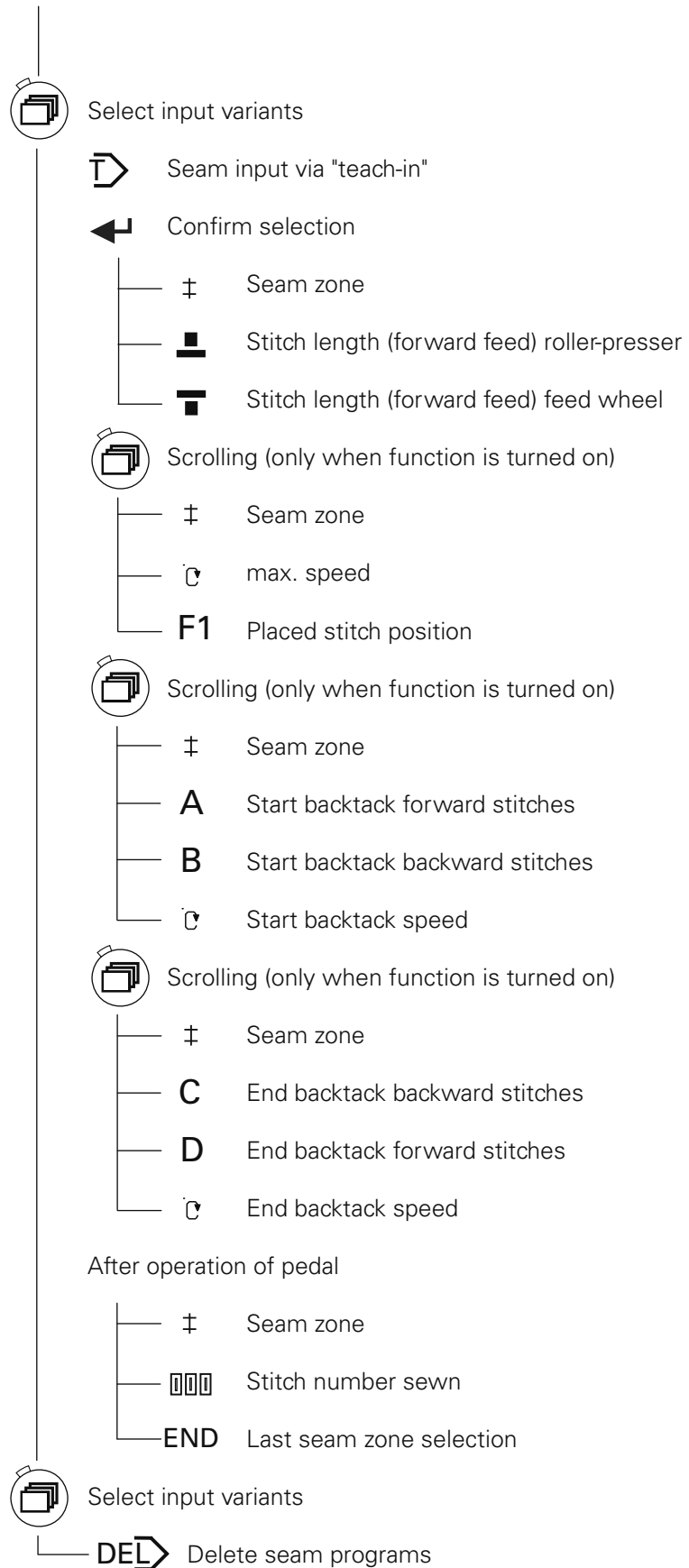

For detailed descriptions of further functions, see Chapter 7.10.03 Function keys

10.02 Seam program input variants

To enter and/or change or delete seam program inputs, there are three basic input variants available:

- Seam program input / alteration (by entering the values),
- Seam input via "teach-in" and
- Deleting seam programs.

The desired input variants can be selected as follows:

- Switch machine on.

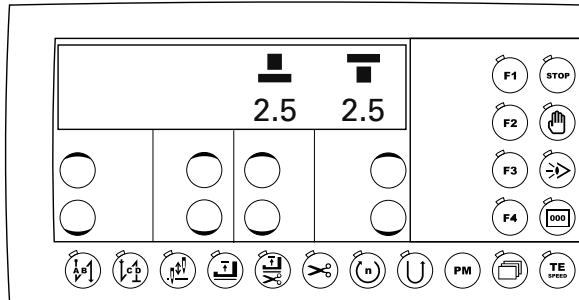

2x



- Press the TE/Speed key twice (LED lights up)

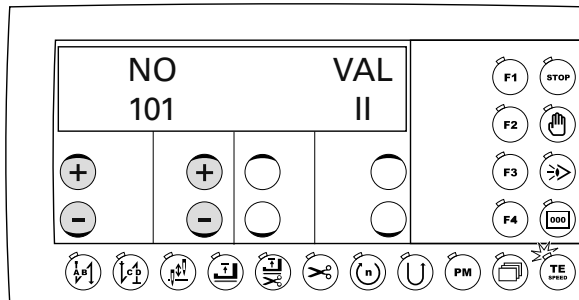

- Press the PM key to call up the seam program input (LED lights up).
- Enter code number, see Chapter 8.09 Entering/changing the template code.

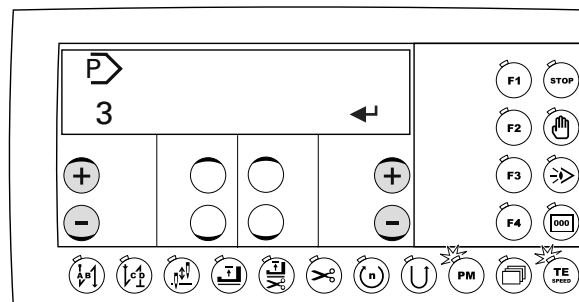

- Select the desired program number by pressing the corresponding +/- key.



- Select the desired input variants (P or T) by pressing the scrolling key (for description of symbols see chapter 7.10.01).



- Confirm the program number by pressing the corresponding +/- key.



- Enter the desired numbers and afterwards conclude the seam program input by pressing the TE/Speed key.

10.03 Changing available seam programs



The following description implies that a seam program has already been set with all the required parameters.

- Switch machine on.
- Call up the input variant "Seam program input / alteration", see Chapter 10.02 Seam program input variants.

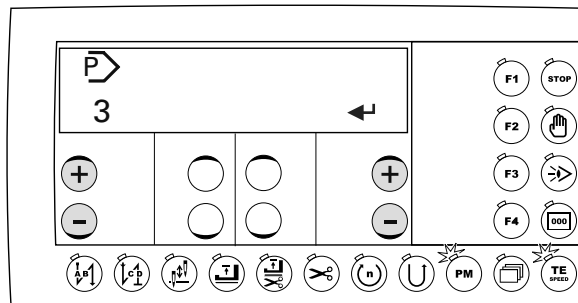

- ● Select the desired program number by pressing the corresponding +/- key.
- ← ● After confirming the selection by pressing the corresponding +/- key, the first of up to five input menus is displayed, in which the parameters of the selected programs can be changed, as described as follows.



Each of the five input menus can be individually selected by pressing the **scrolling** key. Only the input menus of functions which are turned on will be displayed.



By pressing the PM key, the machine moves back to the program selection menu.

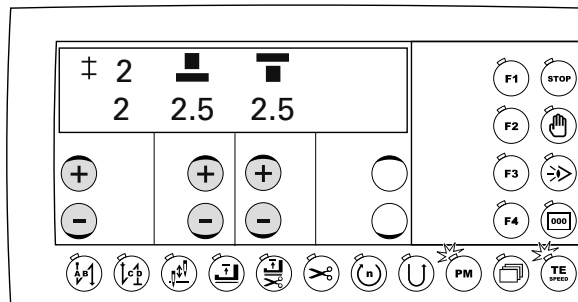



- ± ● Select the desired seam zone by pressing the +/- key.
- ● Select the desired value for the roller-presser stitch length by pressing the +/- key.
- ● Select the desired value for the feed wheel stitch length by pressing the +/- key.



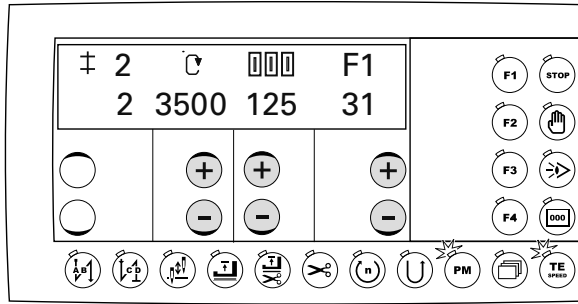

- Call up the next input menu by pressing the scrolling key.



So that the input menu displays as shown, the following functions must be switched on (LEDs light up):

-  **F1** (Placed stitch), - and / or
-  **(n)** Speed (Speed limit), - and / or
-  **000** Stitch count

 ● Select the desired value for speed of the current seam zone by pressing the +/- key.

 ● Select the desired value for the number of stitches in the current seam zone by pressing the +/- key.

F1 ● The placed stitch position is set by turning the handwheel or by pressing the +/- key.

 ● Call up the next input menu by pressing the **scrolling** key.

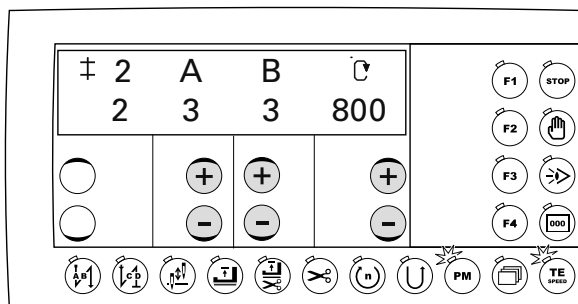

 This input menu can be called up only if the **start backtick** function is switched on (LED lights up).

A ● Select the desired value for the number of start backtick forward stitches (A) for the current seam zone by pressing the +/- key.

B ● Select the desired value for the number of start backtick backward stitches (B) for the current seam zone by pressing the +/- key.

 ● Select the desired value for the start backtick speed of the current seam zone by pressing the +/- key. Whether the start backtick is sewn with constant speed or pedal controlled is determined by the parameter 101.

 ● Call up the next input menu by pressing the **scrolling** key.

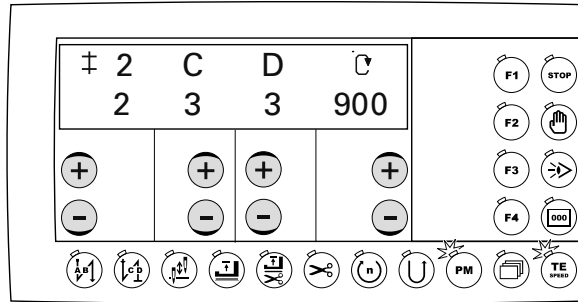

This input menu can be called up only if the **end backtrack** function is switched on (LED lights up).

- C** ● Select the desired value for the number of end backtrack forward stitches (A) for the current seam zone by pressing the **+/- key**.
- D** ● Select the desired value for the number of end backtrack backward stitches (B) for the current seam zone by pressing the **+/- key**.
-  ● Select the desired value for the end backtrack speed of the current seam zone by pressing the **+/- key**.



- Call up the next input menu by pressing the **scrolling** key.

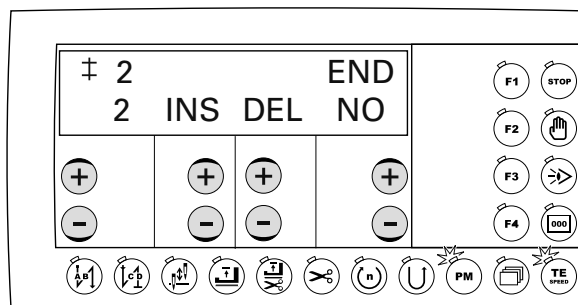

- INS** ● A new seam zone is inserted by pressing the **+/- key**.
- DEL** ● The current seam zone is deleted by pressing the **+/- key**.
- END** ● Pressing the **+/- key** determines whether the selected seam zone of the last program is ("YES") or whether a further seam zone ("NO") should be attached.



- By pressing the **scrolling** key, the first input menu is called up again or



- by pressing the **TE/Speed** key the programmed sewing operation is changed, and the entered values saved.

10.04 Delete seam programs

- Switch machine on.

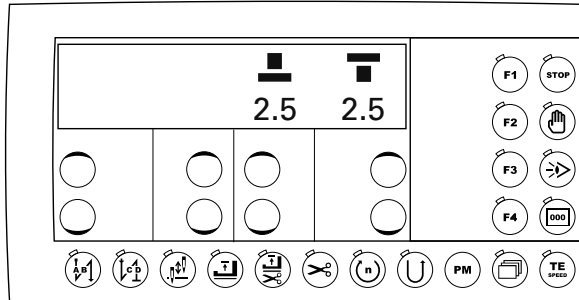

- 2x  ● Press the **TE/Speed** key twice to call up the input mode (LED lights up).

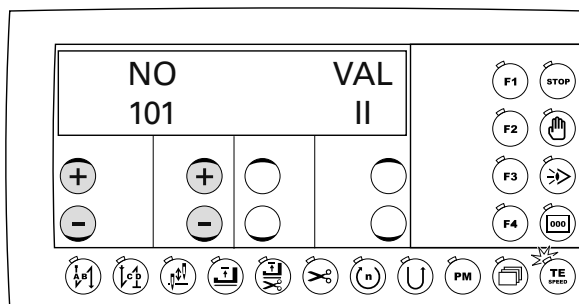

-  ● Press the **PM** key to call up the seam program input (LED lights up).
- Enter code number, see Chapter 8.07 Entering/changing the template code.

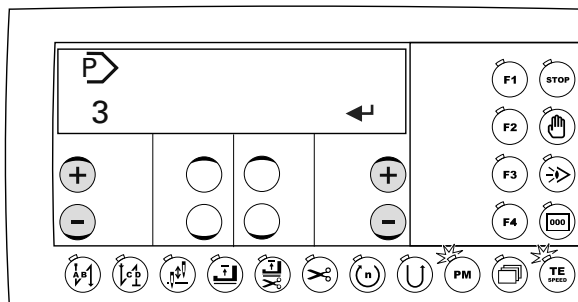

- ● Select the desired program number by pressing the corresponding +/- key.
-  ● Select the input variant "Deleting of seam programs" by using the scrolling key, see chapter 10.02 Seam program input variants.

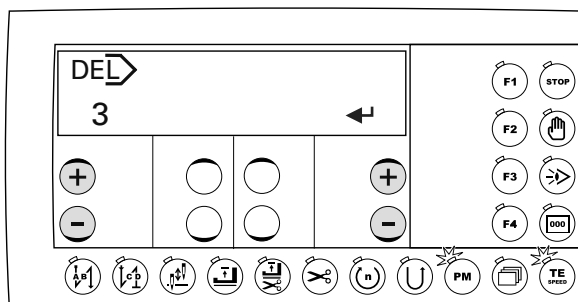

- ← ● Confirm deletion of the program by pressing the corresponding +/- key.
-  ● End the seam program input by pressing the **TE/Speed** key.

10.05 Examples for seam programming

In the following, examples are shown of the procedure for creating seam programs via the seam program input, as well as the teach-in function.



The programming examples shown in the display are only as follows, when no seam program has been entered under the selected program number.

10.05.01 Example for seam program input

The seam to be programmed should
 - contain 5 seam zones
 - and be saved under program number 7.

- Switch machine on.

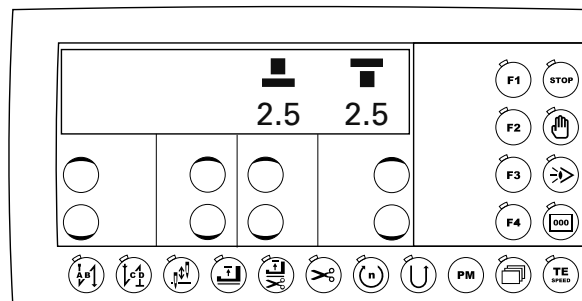

2x

- Press the **TE/Speed** key twice to call up the input mode (LED lights up).

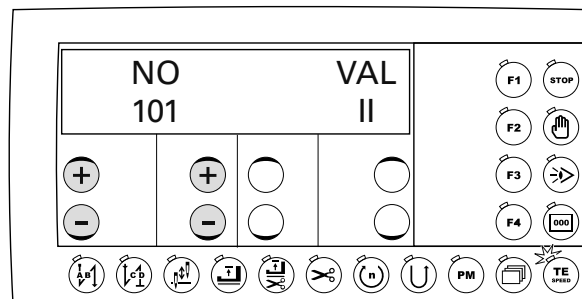

- Press the **PM** key to call up the seam program input (LED lights up).
- Enter code number, see Chapter 8.07 Entering/changing the template code.

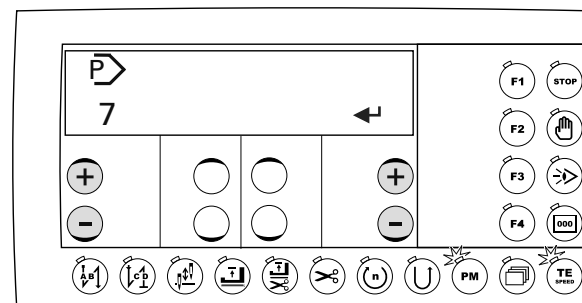

- ● Select the program number 7 by pressing the corresponding +/- key.
- ⬅ ● Confirm selection by pressing the +/- key. The display switches to the input of the first seam zone.

The first seam zone should contain

- a double start backtack (2 stitches forwards and backwards),
- backtack speed of **700** min¹,
- stitch count (**5** stitches)
- and a stitch length (for roller-presser and feed wheel) of **3.5** mm.

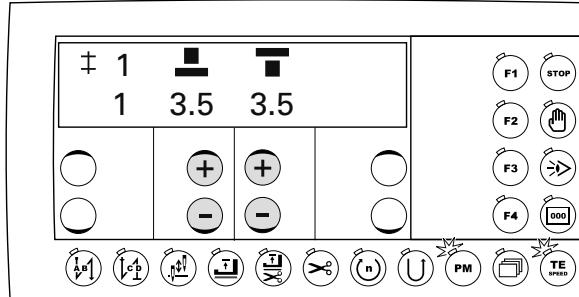

- Set the value for the roller-presser stitch length to "3.5" by pressing the +/- key.

- Set the value for the feed wheel stitch length to "3.5" by pressing the +/- key.



- Switch on the corresponding function by pressing the start backtack key. The display changes for entering the value for the start backtack.

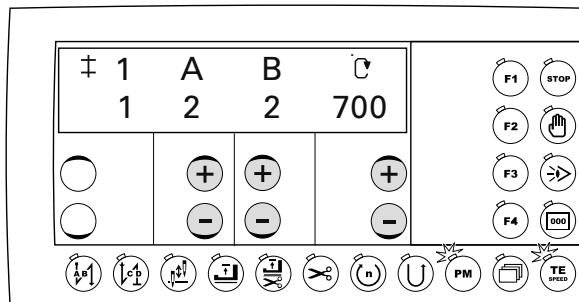

- A ● Set the value for the number of forward stitches to "2" by pressing the +/- key.

- B ● Set the value for the number of backward stitches to "2" by pressing the +/- key.

- C ● Set the value for the backtack speed to "700" by pressing the +/- key.



- Switch on the corresponding function by pressing the **stitch count** key. The display changes for entering the number of stitches.



- If the "stitch count" function was already switched on, the menu appears for entering the stitch number after pressing the **scrolling** key.

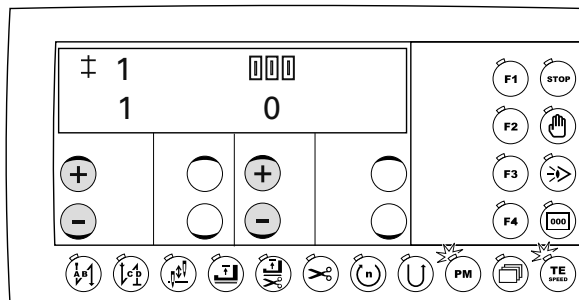

- Set the value for the number of stitches to "5" by pressing the +/- key.



The following display is called up by pressing the scrolling key.

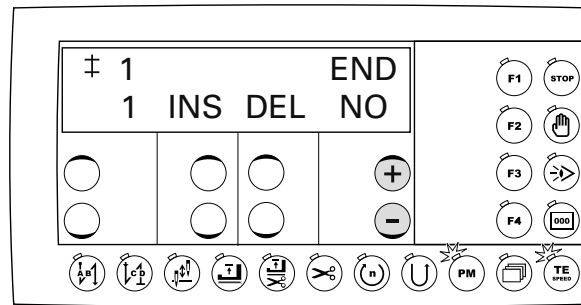

END ● Select "NO" by pressing the +/- key to add further seam zones.

± ● Switch to the second seam zone by pressing "+" on the +/- key.

The second seam zone should

- have a stitch length (for roller-presser and feed wheel) of 2.5 mm
- and a stitch count should be carried out (1 stitch)

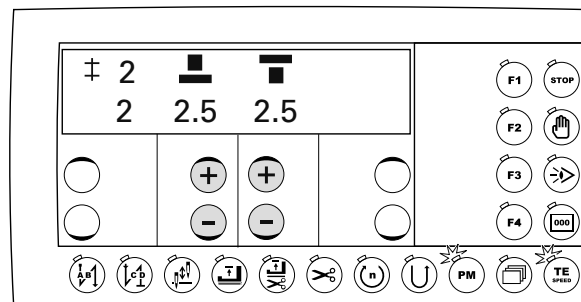

▬ ● Set the value for the roller-presser stitch length to "2.5" by pressing the +/- key.

▬ ● Set the value for the feed wheel stitch length to "2.5" by pressing the +/- key.



● Switch on the corresponding function by pressing the **stitch count** key. The display changes for entering the stitch number.



● If the "stitch count" function was already switched on, the menu appears for entering the stitch number after pressing the **scrolling** key.

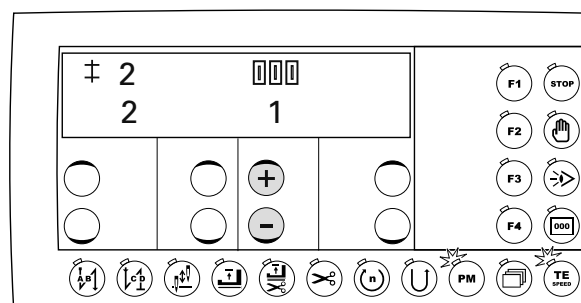

000 ● Set the value for the number of stitches to "1" by pressing the +/- key.

- ⊕ ● Switch to the third seam zone by pressing "+" on the +/- key.

The third seam zone should

- have a stitch length (for roller-presser and feed wheel) of 4 mm
- one stitch count carried out (2 stitches)
- and the seam sewn in reverse.

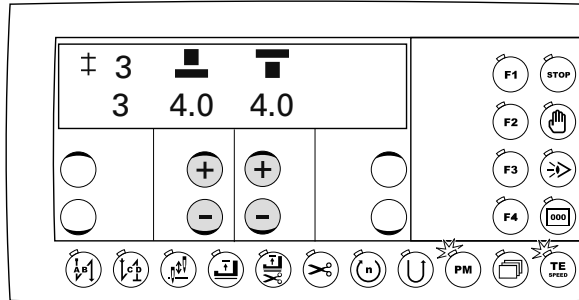

- Switch to the stitch length input menu by pressing the **scrolling** key.



- Set the value for the roller-presser stitch length to "4.0" by pressing the +/- key.



Set the value for the feed wheel stitch length to "4.0" by pressing the +/- key.



- Switch on the corresponding function by pressing the **stitch count** key. The display changes for entering the stitch number.



- If the "stitch count" function was already switched on, the menu appears for entering the stitch number after pressing the **scrolling** key.

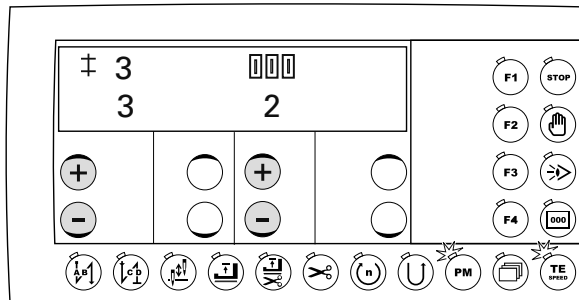

- Set the value for the number of stitches to "2" by pressing the +/- key.



- Switch on the "Reverse sewing" function by pressing the corresponding key.



- Switch to the fourth seam zone by pressing "+" on the +/- key.

- The fourth seam zone should
- have a stitch length (for roller-presser and feed wheel) of **5 mm** and
 - one stitch count carried out (**1 stitch**)

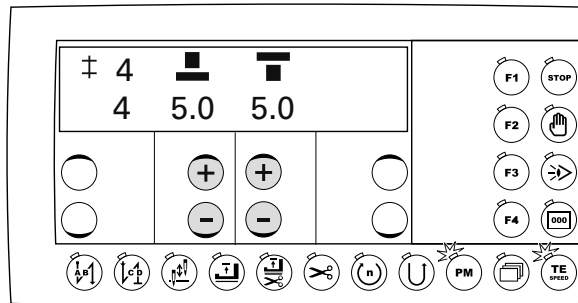

- Set the value for the roller-presser stitch length to "5.0" by pressing the +/- key.

- Set the value for the feed wheel stitch length to "5.0" by pressing the +/- key.

- Switch on the corresponding function by pressing the **stitch count** key. The display changes for entering the stitch number.
- If the "stitch count" function was already switched on, the menu appears for entering the stitch number after pressing the **scrolling** key.

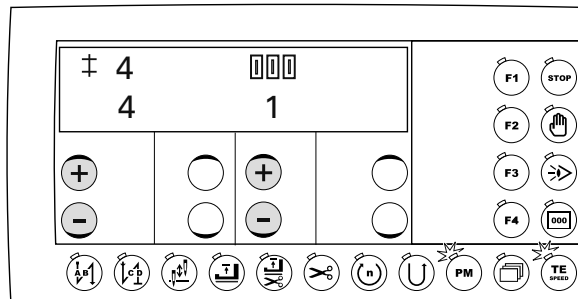

- Set the value for the number of stitches to "1" by pressing the +/- key.

- Switch on the "Reverse sewing" function by pressing the corresponding key.

- Switch to the fifth seam zone by pressing "+" on the +/- key.

The fifth seam zone should

- have a double end backtack and
- have a stitch length (for roller-presser and feed wheel) of **5 mm**
- backtack speed of **700 min¹**
- one stitch count carried out (**1 stitch**)
- and should contain the function thread trimming at seam zone end.

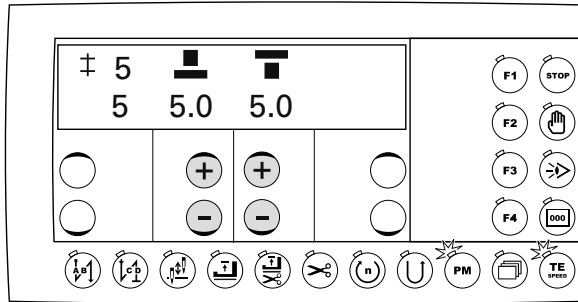

- Set the value for the roller-presser stitch length to "5.0" by pressing the +/- key.

- Set the value for the feed wheel stitch length to "5.0" by pressing the +/- key.

- Switch on the corresponding function by pressing the **end backtack** key. The display changes for entering the stitch number for the end backtack.

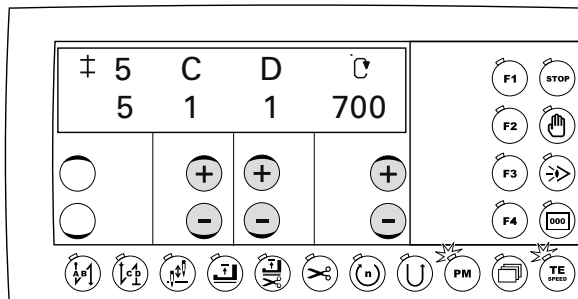

- Set the value for the number of backward stitches to "1" by pressing the +/- key.

- Set the value for the number of forward stitches to "1" by pressing the +/- key.

- Set the value for the backtack speed to "700" by pressing the +/- key.

- Switch on the corresponding function by pressing the **stitch count** key. The display changes for entering the number of stitches.

- If the "stitch count" function was already switched on, the menu appears for entering the stitch number after pressing the **scrolling** key.

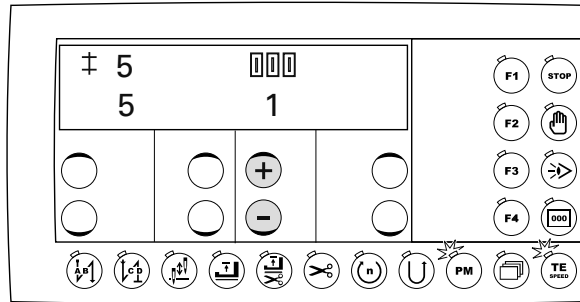

- Set the value for the number of stitches to "1" by pressing the +/- key.



- Switch on the corresponding function for the seam zone end by pressing the thread trimming key.



- The following display is called up by pressing the scrolling key.

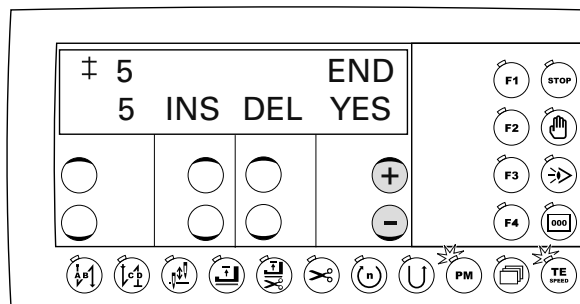

- Select "YES" by pressing the +/- key to conclude the entry of the seam.

- The selected values are taken over by pressing the TE/Speed key and a change is made to the programmed sewing.



If no seam zone end function is switched on, the seam zone end is moved by the pedal function, see Chapter 7.02 Pedal.

10.05.02 Example for seam input via teach-in

The seam to be programmed should

- contain **3** seam zones
- and be saved under program number **8**.

- Switch machine on.

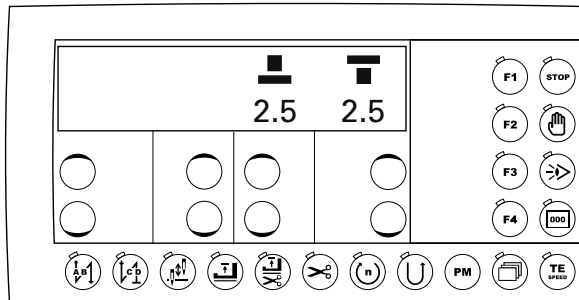

- 2x  ● Press the **TE/Speed** key twice to call up the input mode (**LED lights up**).

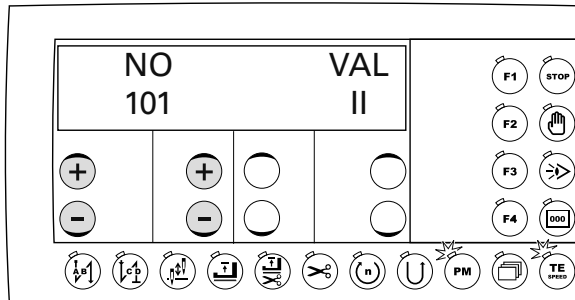

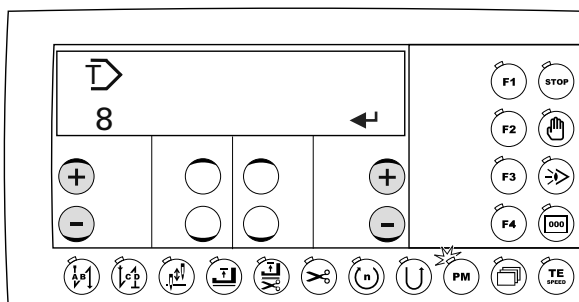

-  ● Press the **PM** key to call up the seam program input (**LED lights up**).
- Enter code number, see Chapter 8.07 Entering/changing the template code.





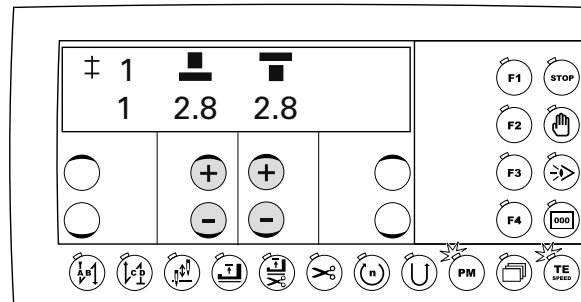

- Call up the input variant "**Seam input via teach-in**" by pressing the **scrolling** key, see Chapter 10.02 Seam program input variants.
- ● Select the program number **8** by pressing the corresponding **+/-** key.
- ⬅ ● Confirm selection by pressing the **+/-** key. The display switches to the input of the first seam zone.

- The first seam zone should contain
- the knee switch at seam zone end function
 - and a stitch length (for roller-presser and feed wheel) of 2.8 mm.

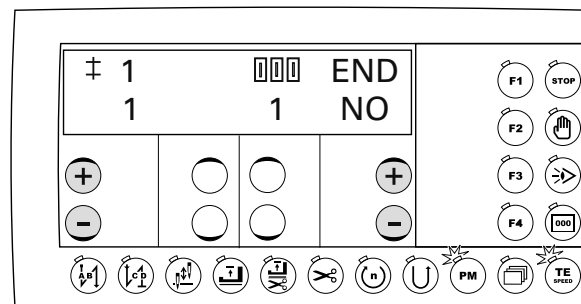

- 
 - Set the value for the roller-presser stitch length to "2.8" by pressing the +/- key.
- 
 - Set the value for the feed wheel stitch length to "2.8" by pressing the +/- key.
- Sew the first seam zone manually.





- 
 - The input of the seam zone end must be carried out after the machine stop. Switch on the "End of section by knee switch" by pressing the knee switch or the F3 key.
- 
 - After sewing, enable the input of further seam zones by pressing "NO" on +/- key.
- 
 - Switch to the second seam zone by pressing "+" on the +/- key.

The second seam zone should contain

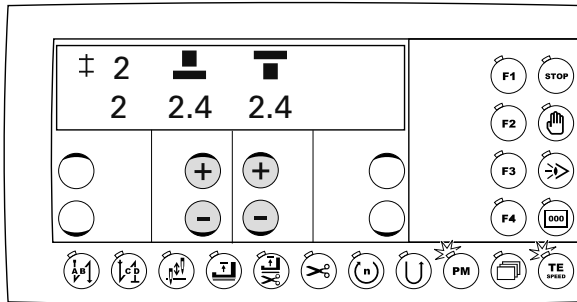
- the knee switch at seam zone end function
- and a stitch length (for roller-presser and feed wheel) of 2.4 mm.



- 
 - Set the value for the roller-presser stitch length to "2.4" by pressing the +/- key.

- 
 - Set the value for the feed wheel stitch length to "2.4" by pressing the +/- key.

- Sew the second seam zone manually.

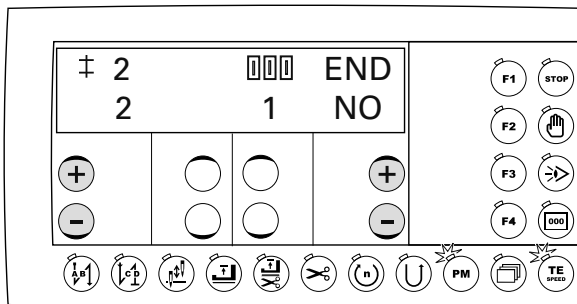



- 
 - The input of the seam zone end must be carried out after the machine stop. Switch on the "End of section by knee switch" by pressing the knee switch or the F3 key.

- 
 - Switch to the third seam zone by pressing "+" on the +/- key.

The third seam zone should contain

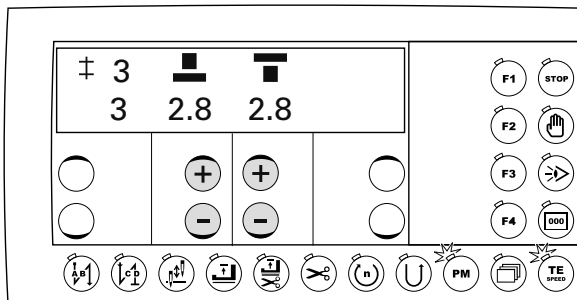
- the thread trimming at seam zone end function
- as well as a stitch length (for roller-presser and feed wheel) of 2.8 mm.



- 
 - Set the value for the roller-presser stitch length to "2.8" by pressing the +/- key.

- 
 - Set the value for the feed wheel stitch length to "2.8" by pressing the +/- key.

- Sew the third seam zone manually.

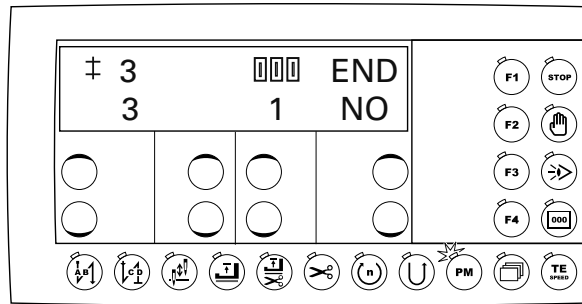

- The input of the seam zone end must be carried out after the machine stop. Activate the seam zone end by the pedal by pressing the pedal in position "-2", see Chapter 7.02 Pedal.



- Switch on the corresponding function for the seam zone by pressing the **thread trimming** key.

- END ● Select "YES" by pressing the +/- key to conclude the entry of the seam.

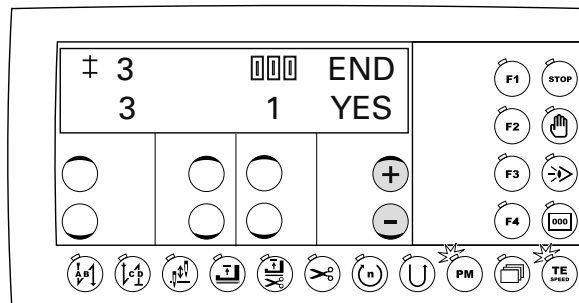

- The teach-in seam programming with three seam zone is completed as follows. The threads are trimmed and the selected values taken over by pressing the **TE/Speed** key. The machine then switches to sewing mode.



If no seam zone end function is switched on, the seam zone end is moved by the pedal function, see Chapter 7.02 Pedal.

10.06 Program management

In program management, the program numbers which are saved in the machine memory or on the SD card are displayed. The programs can be deleted or copied. Conventional SD memory cards up to a maximum of 2 GB can be inserted into the control panel. The machine data is saved in the file "MD" in the subdirectory \P25xx. The programs are saved in the directory \P25xx in the files 03 – 99.

The insertion and removal of the SD memory card is described in Chapter 8.10 **Inserting/removing the SD memory card**.

If the SD memory card is to be formatted using a PC, it must be formatted in "FAT16" format. Alternatively, the SD memory card can also be formatted using the formatting function on the corresponding machine, see Chapter 10.06.08 **Formatting the SD memory card**.

10.06.01 Calling up program management

- Switch machine on.

- 2x  ● Call up input mode (LED lights up).

-  ● Program management is called up by pressing the **scrolling** key.

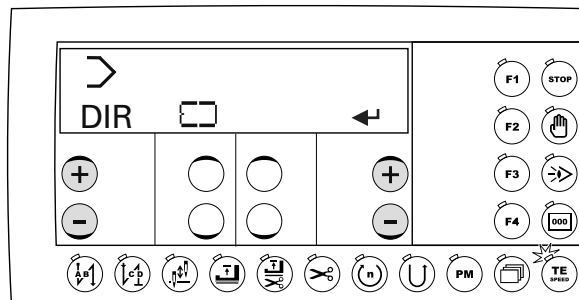

After calling up program management, the first menu item appears (display of the program in machine memory).

Confirm selection of the menu item by pressing the right "+" key.

Further menu items can be scrolled through by pressing the left +/- key, see the following chapter.

The following menu items are available in program management:

- Display of the program in the machine memory
- Display of the program and the machine data on the inserted SD memory card
- Copying of single programs and the machine data onto the SD memory card
- Copying of single programs and the machine data in the machine memory
- Deleting programs in the machine memory
- Deleting programs and machine data on the SD memory card
- Formatting the SD memory card

10.06.02 Displaying programs in the machine memory

- Calling up program management, see Chapter 10.06.01 Calling up program management.

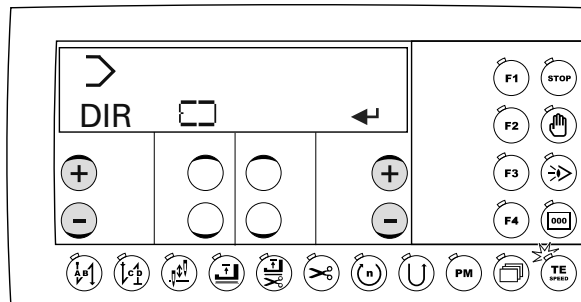

- Press the left +/- key until the corresponding menu item is displayed.
- Confirm selection of the menu items by pressing the right + key.

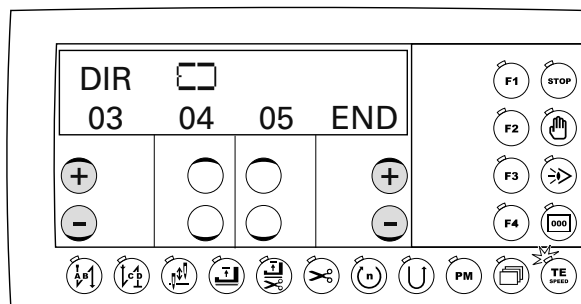

- The machine memory can be scrolled through within the display by pressing "+" on the right +/- key.
- The programs (3 - 99) are displayed. Only occupied program places are displayed.
- Further menu items of program management are called up by pressing the left +/- key.

10.06.03 Displaying programs and machine data on the SD memory card

- Calling up program management, see Chapter 10.06.01 Calling up program management.

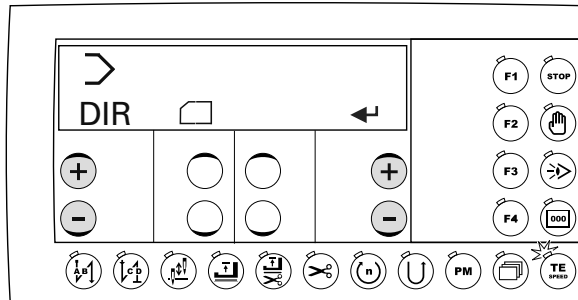

- Press the left +/- key until the corresponding menu item is displayed.
- Confirm selection of the menu items by pressing the right + key.

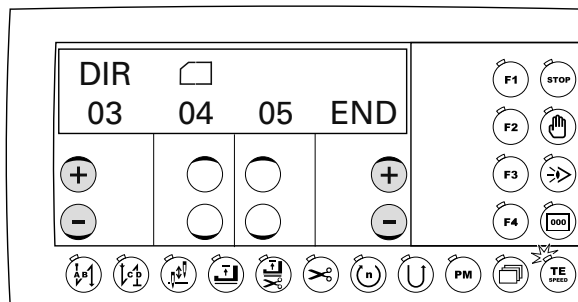

- The SD memory card can be scrolled through within the display by pressing "+" on the right +/- key.
- Programs (3 - 99) and machine data (MD) are displayed. Only occupied program places and saved machine data is displayed.
- Further menu items of program management are called up by pressing the left +/- key.

10.06.04 Copying programs and machine data onto the SD memory card

- Calling up program management, see Chapter 10.06.01 Calling up program management.

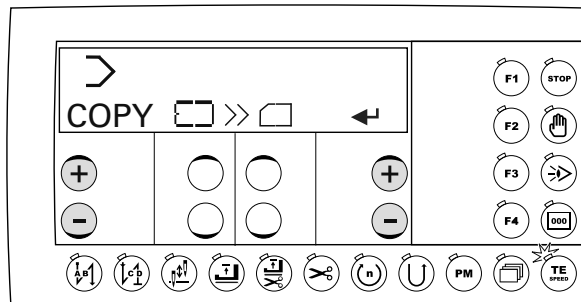

- Press the left +/- key until the corresponding menu item is displayed.
- Confirm selection of the menu items by pressing the right + key.

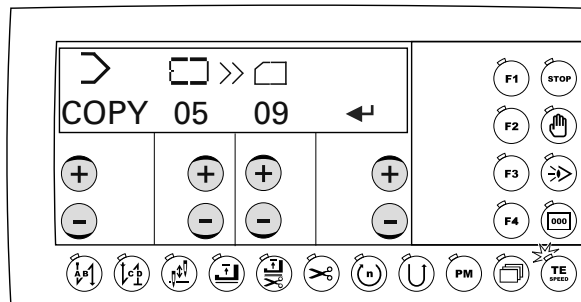

- Select the data which should be copied from the machine memory to the SD memory card (programs 03 - 99, machine data - MD, all programs - ALL) by pressing the +/- key under the symbol of the machine memory.
- When copying programs, select the program number for saving on the SD memory card, by pressing the +/- key under the symbol of the machine memory.
- Confirm the copying process by pressing the right + key.
- Further menu items of program management are called up by pressing the left +/- key.



If a program is already present on the SD memory card, a prompt for confirmation will be displayed. The program will be overwritten by pressing the right + key. Pressing the right - key will cancel the operation.

10.06.05 Copying programs and machine data in the machine memory

- Calling up program management, see Chapter 10.06.01 Calling up program management.

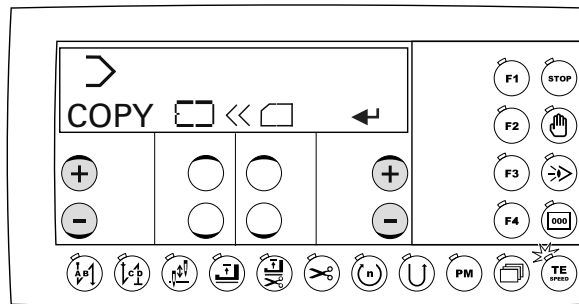

- Press the left +/- key until the corresponding menu item is displayed.
- Confirm selection of the menu items by pressing the right + key.

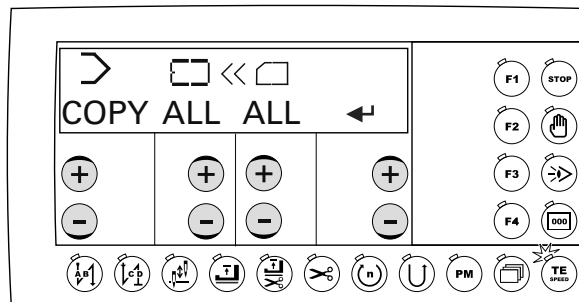

- Select the data to be copied from the SD memory card to the machine memory (program 03 - 99, all programs - ALL) by pressing the +/- key under the symbol of the memory card.
- Select the data for storing in the machine memory by pressing the +/- key under the symbol of the memory card.
- Confirm the copying process by pressing the right + key.
- Further menu items of program management are called up by pressing the left +/- key.



If a program is already present in the machine memory, a prompt for confirmation will be displayed. The program will be overwritten by pressing the right + key. Pressing the right - key will cancel the operation.

10.06.06 Deleting programs in the machine memory

- Calling up program management, see Chapter 10.06.01 Calling up program management.

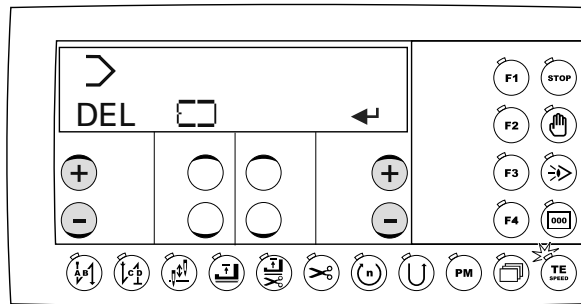

- Press the left +/- key until the corresponding menu item is displayed.
- Confirm selection of the menu items by pressing the right + key.

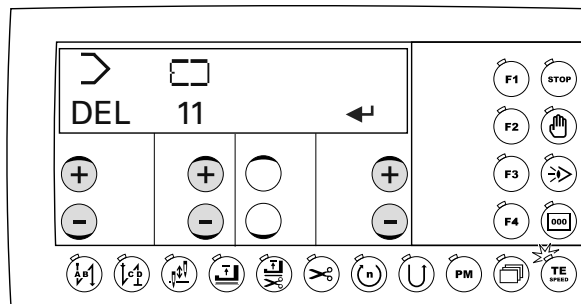

- Select the data which should be deleted from the machine memory (programs 03 - 99, machine data - MD, all data - ALL) by pressing the +/- key under the symbol of the machine memory.
- Confirm the deletion process by pressing the right + key.
- Further menu items of program management are called up by pressing the left +/- key.



Before the deletion process, a prompt for confirmation will be displayed. The program will be overwritten by pressing the right + key. Pressing the right - key will cancel the operation.

10.06.07 Deleting programs and machine data on the SD memory card

- Calling up program management, see Chapter 10.06.01 Calling up program management.

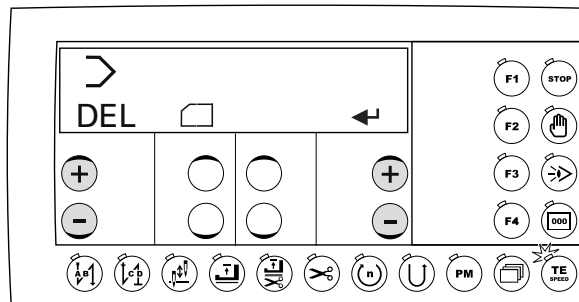

- Press the left +/- key until the corresponding menu item is displayed.
- Confirm selection of the menu items by pressing the right + key.

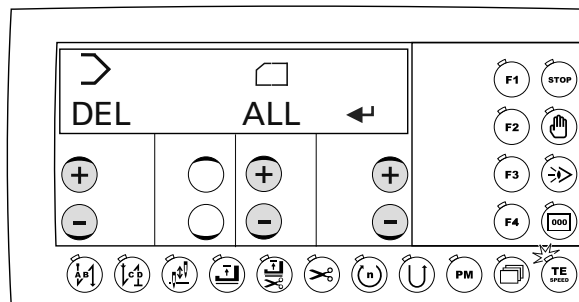

- Select the data which should be deleted from the SD memory card (programs 03 - 99, all programs - ALL, machine data - MD) by pressing the +/- key under the symbol of the SD memory card.
- Confirm the deletion process by pressing the right + key.
- Further menu items of program management are called up by pressing the left +/- key.



Before the deletion process, a prompt for confirmation will be displayed. The program will be overwritten by pressing the right + key. Pressing the right - key will cancel the operation.

10.06.08 Formatting the SD memory card

- Calling up program management, see Chapter 10.06.01 Calling up program management.

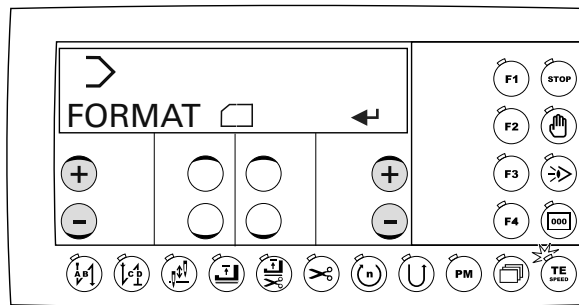

- Press the left +/- key until the corresponding menu item is displayed.
- Confirm selection of menu items by pressing the right + key.



Before the start of formatting, a prompt for confirmation will be displayed. The formatting process is confirmed by pressing the right + key. The formatting process can be cancelled by pressing the right - key.



The card will be completely formatted if it cannot be read. If readable and the directory \P25xx for the 25xx exists, the machine data and the subdirectories for all programs are deleted. If the directory \P25xx for the 25xx does not exist, only the directory is deleted and added. This is to ensure that programs from other machines and other files are not lost.

- Further menu items of program management are called up by pressing the left +/- key.

List of parameters for control P320 / P321



The operator has free access to the "100" parameters.
Parameters "200" - "800" can only be changed after entering a code number and many only be changed by authorised personnel.

Group	Parameter	Description	Setting range	Set value
1	101	Pedal controlled start backtack (I = OFF, II = ON)	I - II	I
	102	Reverse rotation (I = OFF, II = ON)	I - II	I
	103	Placed stitch (I = OFF, II = ON)	I - II	I
	104	Bobbin thread monitoring 0 = Off, 1 = Counter, 2 = Thread monitor	0 - 2	0
	105	Bobbin thread counter	0 - 99999	12000
	106	Bobbin thread remaining counter	0 - 999	100
	108	Display main processor software version		
	109	Display step motor processor software version		
	110	Display control panel software version		
	111	Display sewing drive component software version		
	112	Control panel key tone, (I = OFF, II = ON)	I - II	II
	113	Control panel key tone when moving from one area to another, (I = OFF, II = ON)	I - II	I
	115	Thread clamp (I = OFF, II = ON)	I - II	I
116	Display serial number of machine	-	-	
2	201	Machine configuration 10 = 2521, 11 = 2521 with photo cell,	8 - 14	8
	202	Roller-presser field discharge (OFF = I, ON = II) I = roller-presser is lowered slowly. Should be set for high foot pressure II = roller-presser is lowered quickly. Should be set for low foot pressure	I - II	I

Group	Parameter	Description	Setting range	Set value
2	203	Single stitch button assignment 1 = Single stitch, 2 = Needle up, 3 = Knee switch	1 - 3	1
	204	Half stitch button assignment 1 = Half stitch, 2 = Needle up, 3 = Knee switch	1 - 3	1
	206	Open thread tension on stop and lift roller- presser (I = OFF, II = ON)	I - II	I
	207	Open thread tension after trimming and lift roller-presser (I = OFF, II = ON)	I - II	I
3	301	Thread carrier position t.d.c.	0 - 127	124
	302	Needle position under b.d.c.	0 - 127	10
	303	Thread trimmer magnet position on	0 - 127	20
	304	Thread trimmer magnet position pulse	0 - 127	93
	305	Thread trimmer magnet position off	0 - 127	113
	306	Reverse rotation position	0 - 127	93
	307	Placed stitch position	0 - 127	7
	308	Thread tension ventilation position	0 - 127	30
	309	Thread clamp position on	0 - 127	20
	310	Thread clamp position off	0 - 127	60
4	401	Time delay roller-presser lift	0,01s - 1,5s	0,02s
	402	Delayed start after lowering roller-presser	0,01s - 1,5s	0,15s
	403	Set roller-presser lift (must be increased for high foot pressure)	0,01s - 0,2s	0,03s
	404	Thread trimmer magnet pulse	10 -50%	35%
	405	Time to clean the bobbin thread monitor	0,01s - 1,5s	0,25s
5	501	Maximum speed	100 - 3500	3500
	502	Start backtack speedI	100 - 1500	700
	503	End backtack speedI	100 - 1500	700
	504	Soft start speed	100 - 3500	1500
	505	Soft start stitch	0 - 15	0
	601	Move roller-presser and feed wheel step motor		

Group	Parameter	Description	Setting range	Set value
6	602	Inputs: 0123456789ABCDEF 0 = Needle mid point (E16) 1 = Needle mid point (E15) 2 = Intermittent coding (E14) 3 = Free (E13) 4 = Free (E12) 5 = Free (E11) 6 = Free (E10) 7 = Free (E9) 8 = Emergency button (E8) 9 = Bobbin thread counter (E7) A = Knee switch (E6) B = Photo cell (E5) C = Starting inhibitor (E4) D = Free (E3) E = Free (E2) F = Free (E1)		
	603	Machine drive in home position see set-up-instructions	0 - 127	8 ± 2
	604	Run cold start		
	605	Stitch process with step motors by handwheel		
	606	Display speed control unit value		
	701	P-section speed regulator	1 - 50	30
	702	I-section speed regulator	0 - 100	50
	703	P-section position regulator	1 - 50	20
	704	D-section position regulator	1 - 100	30
	705	Time for position regulator	0 - 100	25
	706	P-section position regulator for remainder brake	1 - 50	25
	707	D-section position regulator for remainder brake	1 - 50	15
	708	Maximum torque for remainder brake	0 - 100	0
	709	Minimum machine speed	3 - 64	6
	710	Maximum machine speed	1 - 35	35
	711	Maximum motor speed	1 - 35	35
	712	Positioning speed	3 - 25	18
	713	Acceleration ramp	1 - 50	35
	714	Braking ramp	1 - 50	30

Group	Parameter	Description	Setting range	Set value
7	715	Reference position	0 - 127	10
	716	Dead man time	0 - 255	40
	717	Motor starting current	3 -10	8
	718	Vibration filter	1 -10	6
	719	Assign direction of rotation	0 - 1	0
	720	Move positioner	1 - 2	2
8	801	Function group 100 access authorisation (Operator level)	0 - 1	0
	802	Function group 200 access authorisation (Technician level)	0 - 1	1
	803	Function group 300 access authorisation (Sewing motor positions)	0 - 1	1
	804	Function group 400 access authorisation (Times)	0 - 1	1
	805	Function group 500 access authorisation (Counter and revolution speed)	0 - 1	1
	806	Function group 600 access authorisation (Service)	0 - 1	1
	807	Function group 700 access authorisation (Sewing motor)	0 - 1	1
	808	Function group 800 access authorisation (Access authorisation)	0 - 1	1
	809	Programming access authorisation	0 - 1	1
	810	Input access code	0 - 9999	2500

10.08 Error Messages and Description

Error	Description
E 1	System error
E 2	Sewing motor E002/BB/xxx BB = 20: Deadman 02: Position forwards 03: Position in reverse 05: Position by shortest route 09: Write parameter 10: Speed 0A: Reset stitch counter 0B: Stop after xxx stitches 30: Timeout for increasing speed 31: Timeout from uncertain positioning 32: Timeout from deadman command 33: Timeout for deleting errors 34: Timeout for emergency stop 35: Timeout for writing parameters 36: Timeout for resetting stitch counter 37: Timeout for stop command after x stitches 38: Timeout for initialisation 39: Establishing contact when turned on xxx = sewing motor control unit error byte (see Motor Errors)
E 3	Section
E 4	End of section
E 5	Pedal or half stitch button or single stitch button (on machine head) activated when machine turned on
E 6	Communication error with the step motor processor
E 7	End of ramp
E 8	Needle drive end point not found
E 9	Needle drive mid-point not found
E 10	Step motor processor error
E 11	Step motor step frequency too high
E 12	Sewing displacement error
E 13	Docu-seam system error
E 14	Incorrect program number (larger than 99)
E 15	Incorrect section number
E 16	Memory full
E 17	Incorrect stitch length
E 18	Unused
E 19	External control interface
E 20	Incorrect control
E 21	Power supply unit overloaded (24V)
E 22	Mains voltage
E 23	Power supply 24V too low

Error	Description
	Error in SD-memory card reader
Error 27 - 1	No SD-memory card inserted
Error 27 - 2	Wrong card (does not match the 2521)
Error 27 - 3	Card not inserted correctly
Error 27 - 4	Card with write protection
Error 27 - 5	Data error on SD-memory card
Error 27 - 6	Formatting failed
Error 27 - 7	File does not match the 2521
Error 27 - 8	Incorrect file size
Error 27 - 9	Transfer error
Error 27 - 10	Data could not be deleted

10.09 Motor Errors

Error	Description
33	Invalid parameter value
35	Communication error
36	Init not ready
37	Command overrun
64	Mains off during initialisation
65	Excess current directly after mains on
66	Short circuit
68	Excess current during operation
70	Motor blocked
71	No incremental plug
74	Incremental transducer missing for transmission/reduction
173	Motor blocked in 1st stitch
175	Interior starting error
222	Dead man monitoring

11 Care and maintenance

11.01 Servicing and maintenance intervals

Clean the hook compartment	Daily, several times if in continuous use
Check the oil level	Daily, before starting the machine
Check/adjust the air pressure	Daily, before starting the machine
Clean the filter of the air filter/lubricator	As required



These maintenance intervals are calculated for the average running time of a single shift operation. If the machine is operated more than this, shorter intervals are recommended.

11.02 Cleaning the machine

The cleaning cycle required for the machine depends on following factors:

- Single or several shift operation
- Amount of dust resulting from the workpiece

It is therefore only possible to stipulate the best possible cleaning instructions for each individual case.



For all cleaning work the machine must be disconnected from the mains by switching off the on/off switch or by removing the mains plug!
Danger of injury if the machine suddenly starts up .

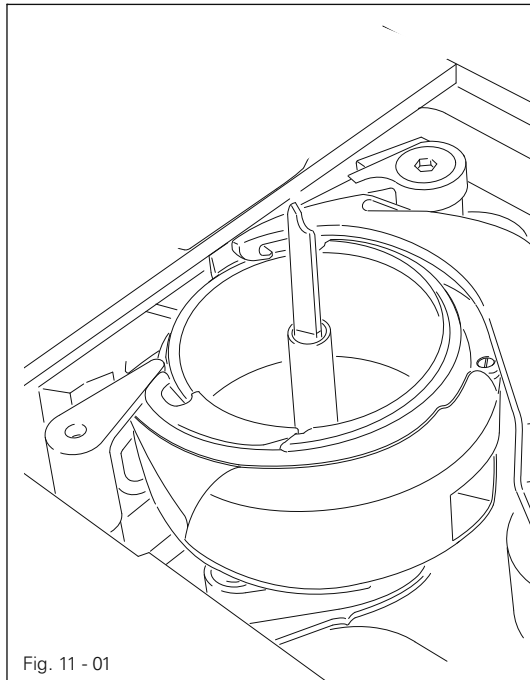

To avoid breakdowns, the following cleaning work is recommended for single shift operation:

- Open the bed slide and remove the bobbin.
- Clean the hook and hook compartment daily, several times if in continuous use.
- Set the bobbin in position and close the bed slide.

11.03 Lubricating

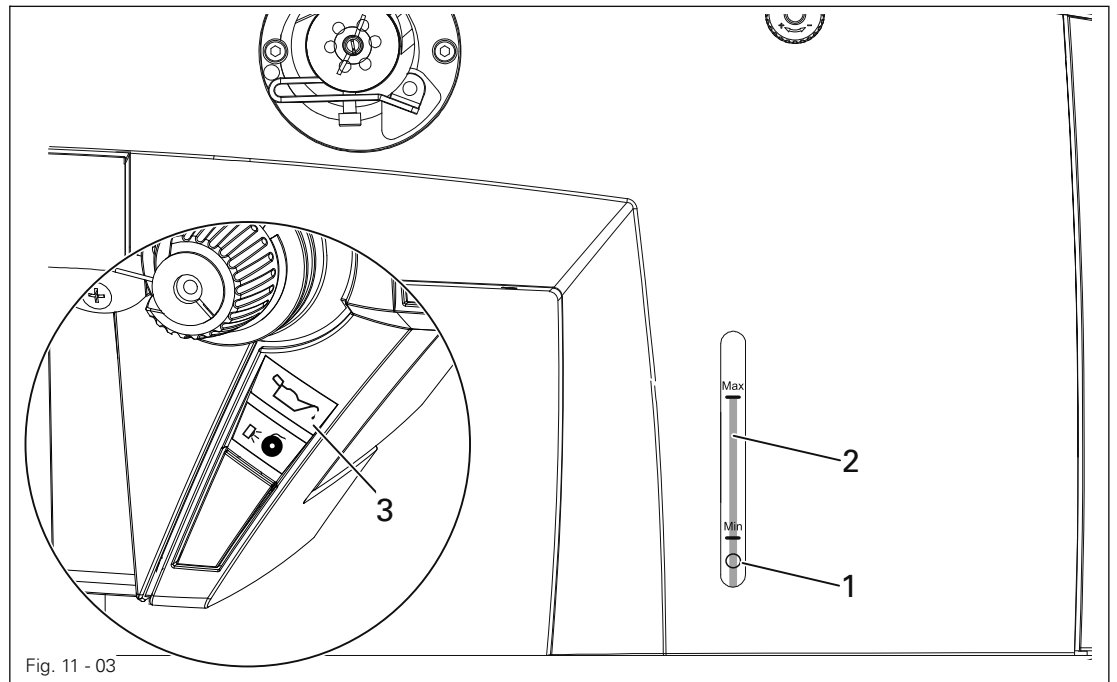

Before commissioning the machine, fill in oil through hole 1 until the oil level indicator 2 is at the "MAX" marking.



The oil level is controlled by sensor.
When the minimum oil level is reached, key 3 on the machine head shines red.
If required, fill oil into the tank through hole 1.
Oil level indicator 2 must not exceed the "MAX" marking.



Only use oil with a medium viscosity of $22.0 \text{ mm}^2/\text{s}$ at 40°C and a density of $0.865 \text{ g}/\text{cm}^3$ at 15°C !

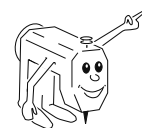

We recommend PFAFF sewing-machine oil, part No. 280-1-120 144.

11.04 Cleaning the blower air filter

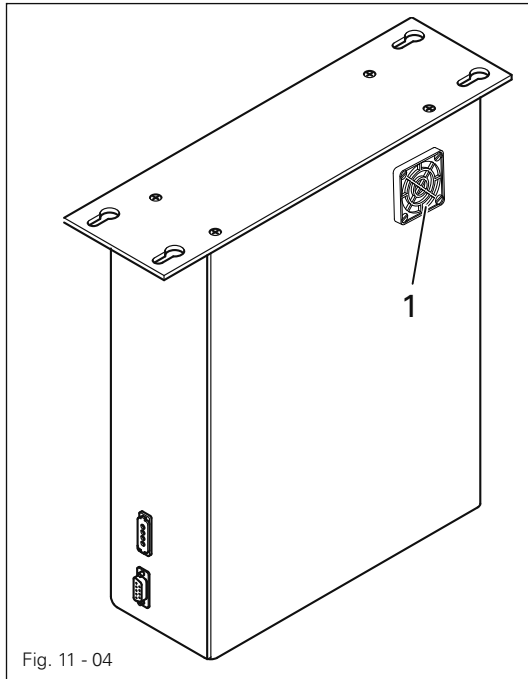

Fig. 11 - 04

- Remove cover 1.
- Take out filter element and clean with compressed air.
- Insert the clean filter element and replace cover 1.

11.05 Checking/regulating the air pressure

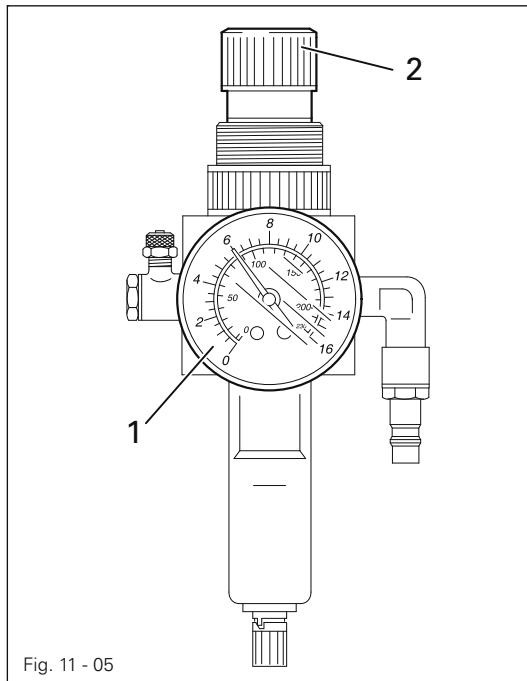

Fig. 11 - 05

- Check the air pressure on gauge 1 every time before operation.
- Gauge 1 must show a pressure of 6 bar.
- Regulate this pressure if required.
- To do so, pull knob 2 up and turn it accordingly.

11.06 Emptying/cleaning the water bowl of the air filter/regulator

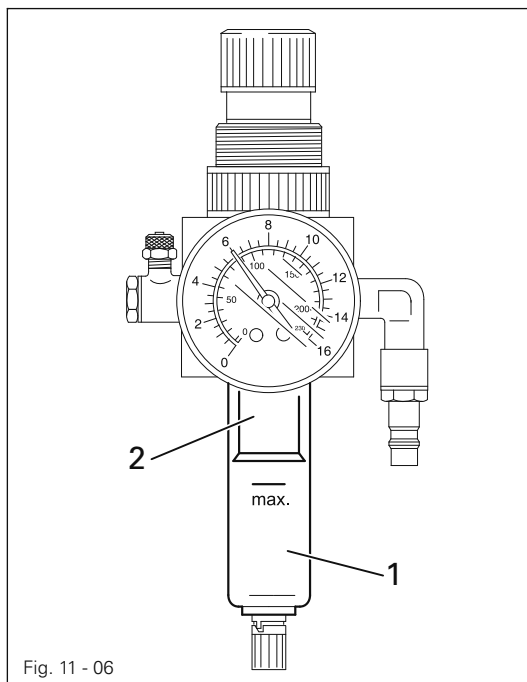

Fig. 11 - 06



Switch off the machine.
Disconnect the air hose at the air filter/regulating unit.

Emptying the water bowl

- Water bowl 1 empties itself automatically when the air hose is disconnected from the air filter/regulator.

Cleaning the filter

- Unscrew water bowl 1 and take out filter 2.
- Clean the filter with compressed air or with isopropyl-alcohol, part number 95-665735-91.
- Screw in filter 2 and screw on water bowl 1.

This is a list of the most important wearing parts.

A detailed parts list for the complete machine is included with the accessories.

In case of loss, the parts list can be downloaded from the internet address

www.pfaff-industrial.com/pfaff/de/service/downloads As an alternative to

the internet download the parts lists can also be ordered in book form under

part no. 296-12-19 155.



91-164 697-93/001

(Roller presser, with 30 mm dia., 4.0 mm wide, toothed)

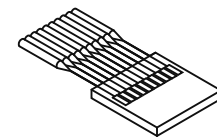
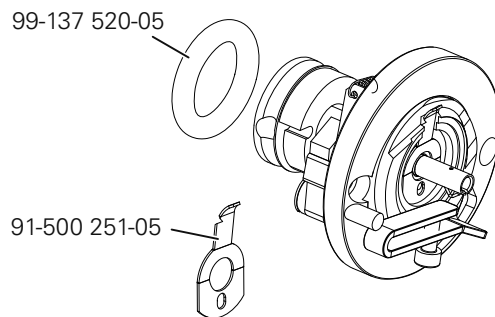
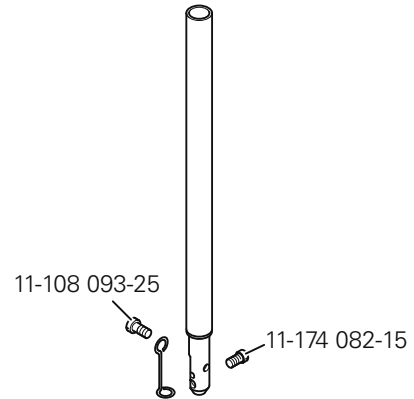
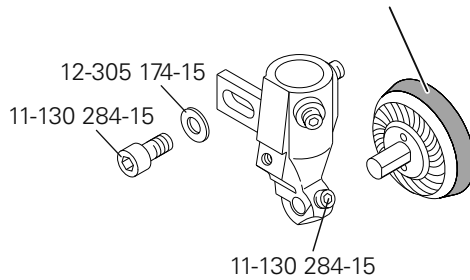

System 134 - 35

-900/81

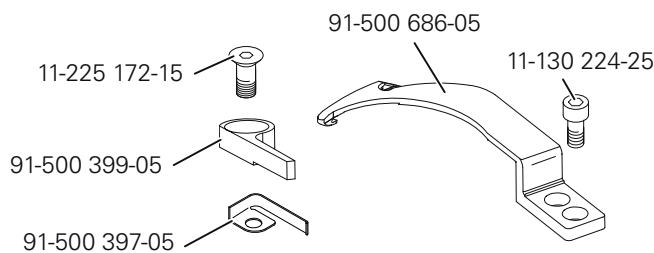

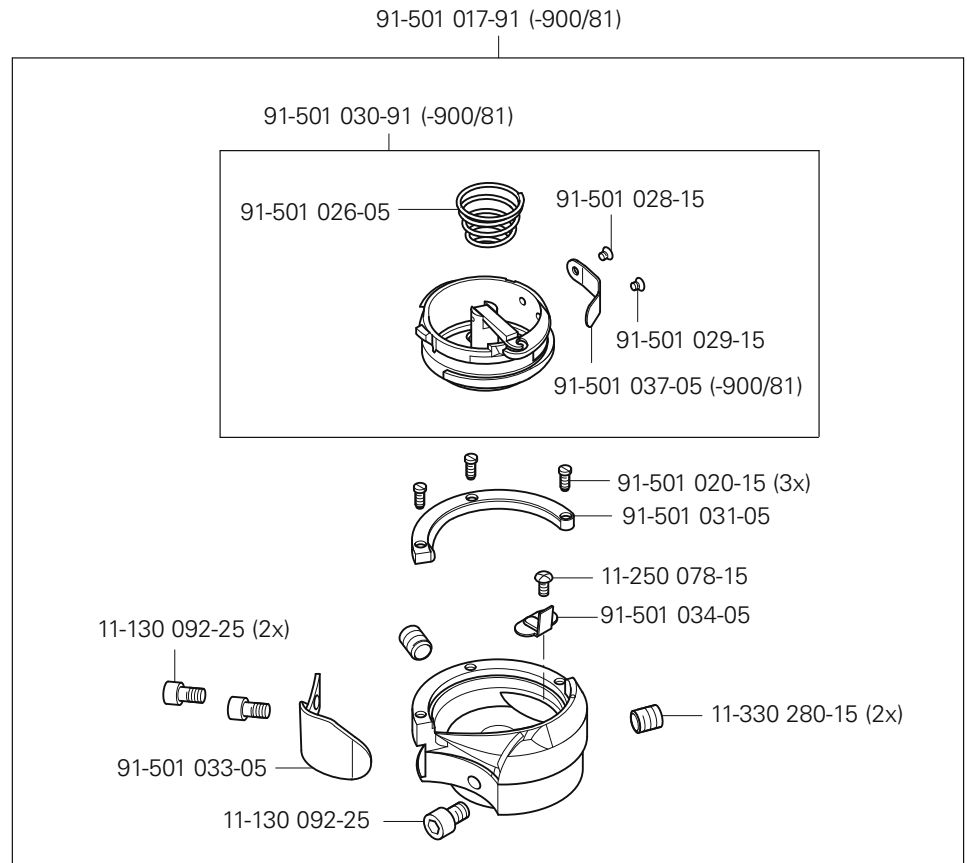
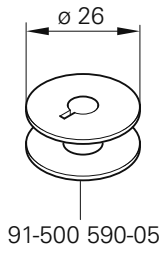



Europäische Union
Wachstum durch Innovation – EFRE



PFAFF Industriesysteme und Maschinen AG

Hans-Geiger-Str. 12 - IG Nord
D-67661 Kaiserslautern

Phone: +49-6301 3205 - 0

Fax: +49-6301 3205 1386

E-mail: info@pfaff-industrial.com